

Section 1
Aluminum Hardware





Trendy Fittings with Passion

Range 1

ALUMINUM FITTINGS



www.domusitalya.com

info@domusitalya.com





Trendy Fittings with Passion

Part 1
DOOR HINGES



www.domusitalya.com

info@domusitalya.com

Galeon^{by} D.I.
Made In China

DOOR HINGES

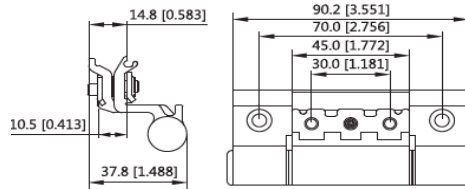

Code
AH201JLHYA01

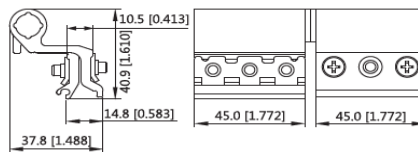

Code
AH202JLHYA02

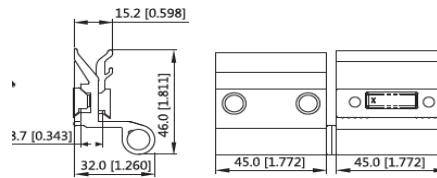

Code
AH203JLHYA05

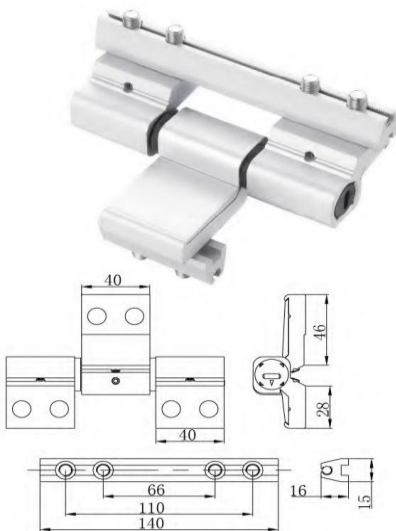

Code
AH204WS4090

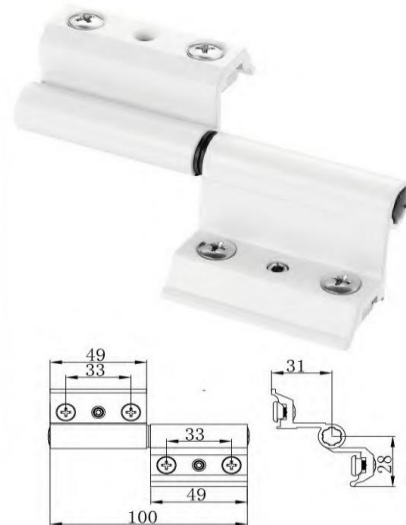

Code
AH205WS4100

DOOR HINGES

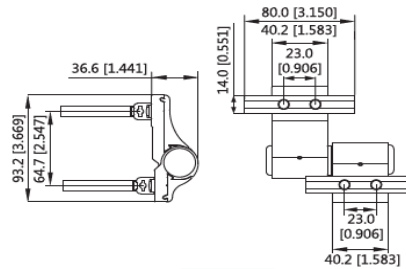

Code
AH206JLHYB03

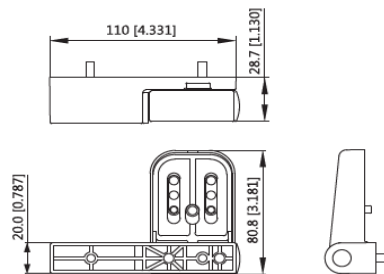

Code
AH207JLHYB04

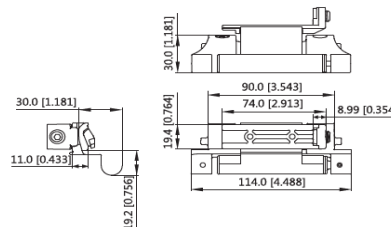

Code
AH208JLHYA09

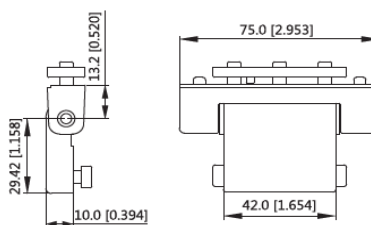

Code
AH209JLHYB02

DOOR HINGES

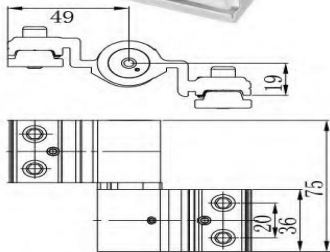

Code

AH210WS4050

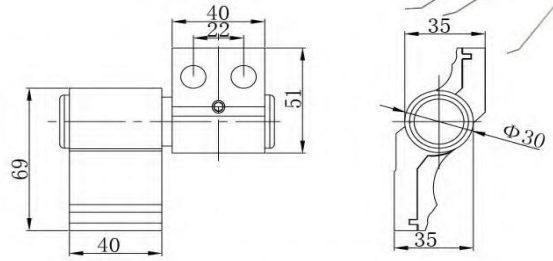

Code

AH211WS4060

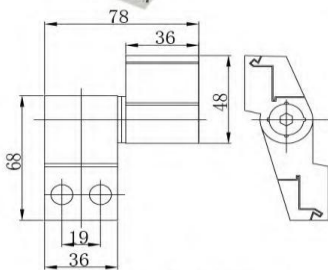

Code

AH212WS4070

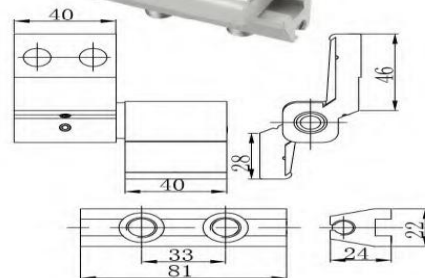

Code

AH213WS4080

DOOR HINGES



Code
AH214TY194
95 mm



Code
AH215TY87
100 mm



Code
AH216TY200
120 mm



Code
AH217TY86
100 mm



Code
AH218TYA133A
132 mm



Code
AH219TYA133B
83 mm

DOOR HINGES

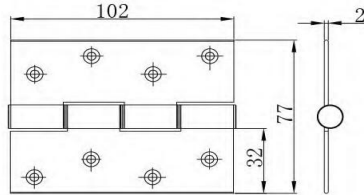

Code
AH220WS4020

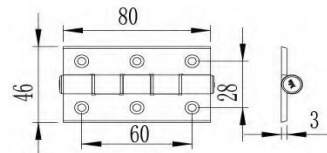

Code
AH221WS4480

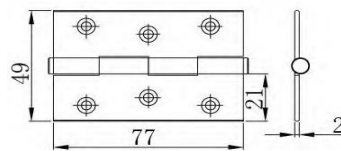

Code
AH222WS4430

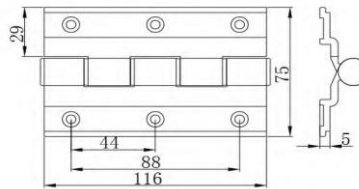

Code
AH223WS4040

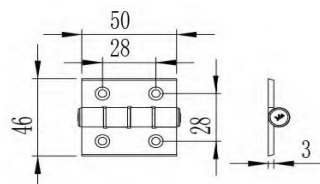

Code
AH224WS4470

DOOR HINGES

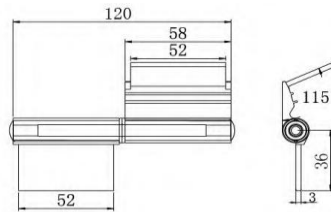

Code
AH225WS4351

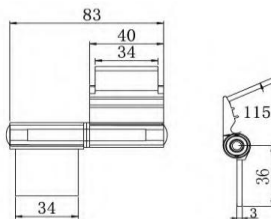

Code
AH226WS4350

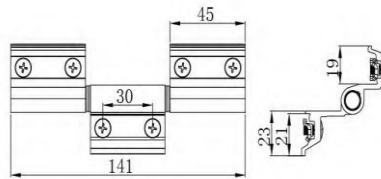

Code
AH227WS4320

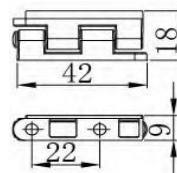

Code
AH228WS4450



Trendy Fittings with Passion

Part 2
BOLTS & CATCHES



www.domusitalya.com

info@domusitalya.com

Galeon^{by} D.I.
Made In China

DOOR BOLTS

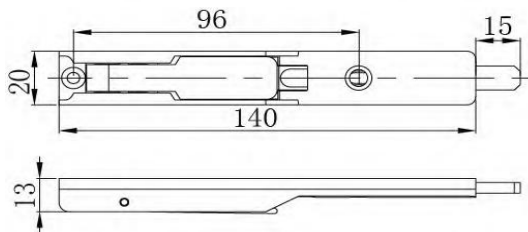

Code
AH411WS36401

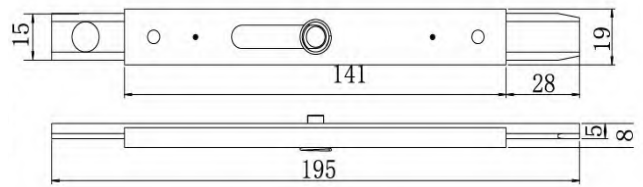

Code
AH417WS36411

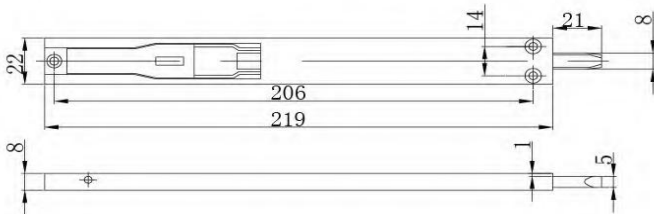
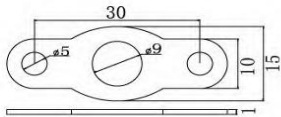

Code
AH403WS3646

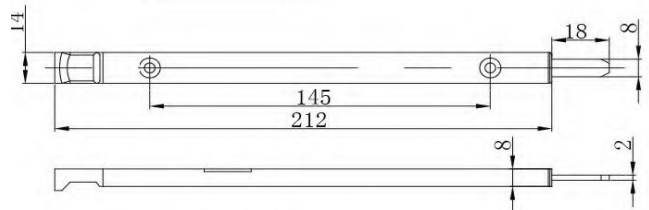
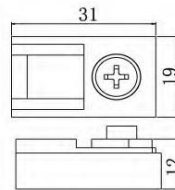

Code
AH405WS3645

WINDOW CATCHES

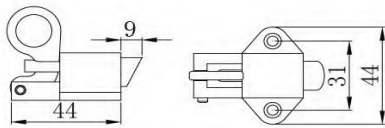

Code
AH431WS3652

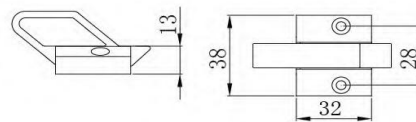

Code
AH438WS3653

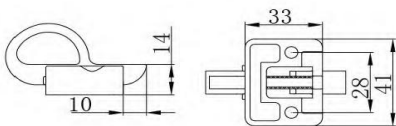

Code
AH418WS3654

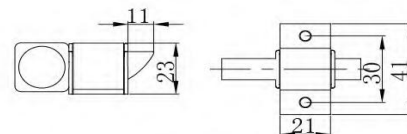

Code
AH421WS3651



Trendy Fittings with Passion

Part 3
ROLLERS



www.domusitalya.com

info@domusitalya.com



Galeon^{by} D.I.
Made In China

ROLLERS

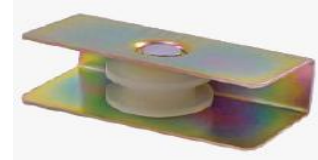

Code

AH301YTC10015



Code

AH302ULI330



Code

AH303YTC10014B



Code

AH304YTC10014A

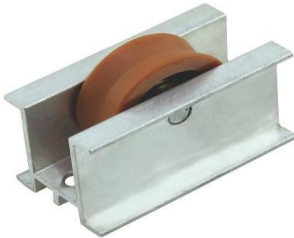

Code

AH310YTC10014



Code

AH312YTC10014



Code

AH313YTC10016A



Code

AH314YTC10016B

ROLLERS



Code

AH307YTC1002



Code

AH308YTC1013



Code

AH309YTC10013A



Code

AH315YTC10013



Code

AH311YTC1001



Code

AH316YTC10012



Code

AH313YTC10017



Code

AH314YTC10017A

ROLLERS



Code

AH315YTC10014E



Code

AH317YTC0028



Code

AH318YTC0032



Code

AH319YTC0033

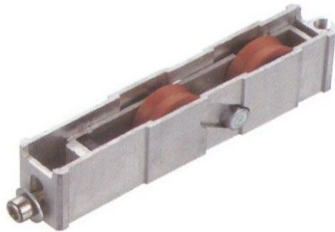

Code

AH320YTC0035



Code

AH321YTC0034



Code

AH322YTC0044



Code

AH323YTC0039

ROLLERS



Code

AH324YTC0037

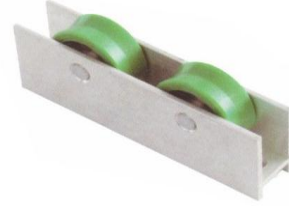

Code

AH325YTC0045



Code

AH326YTC0054

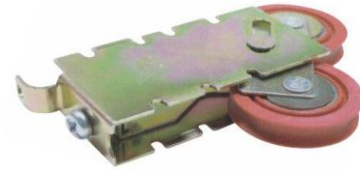

Code

AH327YTC0046



Code

AH328YTC0050



Code

AH329YTC0059



Code

AH330YTC00501



Code

AH331YTC0052



Trendy Fittings with Passion

Part 4
FITTINGS



www.domusitalya.com

info@domusitalya.com

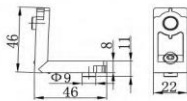

Galeon^{by} D.I.
Made In China

FITTINGS

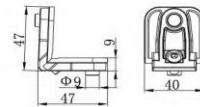

Code

AH351SWC5010



Code

AH352SWC5020

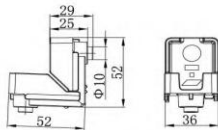

Code

AH353SWC5140

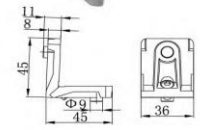

Code

AH354SWC5070

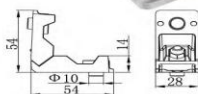

Code

AH355SWC5170

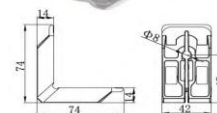

Code

AH356SWC5200

FITTINGS

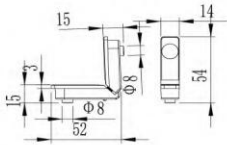

Code

AH357SWC5015

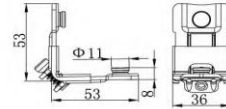

Code

AH358SWC5210

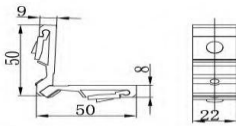

Code

AH359SWC5230

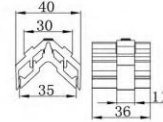

Code

AH360SWC5250

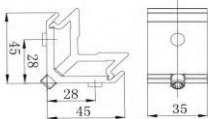

Code

AH361SWC5250

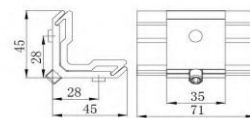

Code

AH362SWC5224

FITTINGS

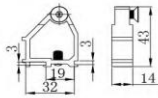

Code
AH363SWC5280

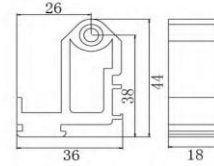

Code
AH364SWC5310

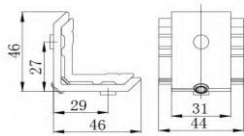

Code
AH365SWC5223

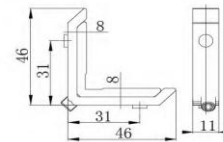

Code
AH366SWC5221

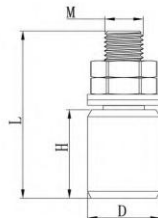

Code
AH367SWC6020

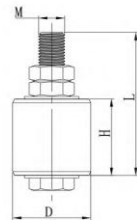

Code
AH368SWC6040



Trendy Fittings with Passion

Part 5
FRICTION STAYS



www.domusitalya.com

info@domusitalya.com

Galeon^{by} D.I.
Made In China

FRICION STAYS FOR WINDOWS

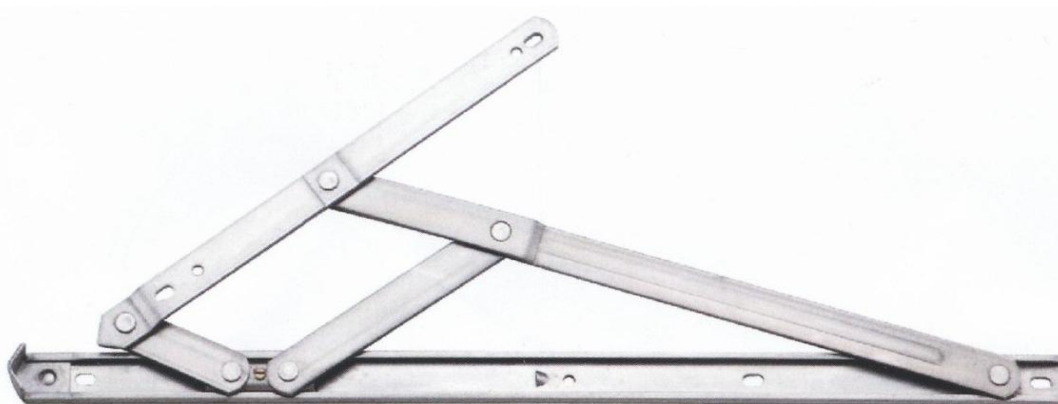

Code	Thickness	Channel	Length		Material
AH2225161820	1.6 mm	18 mm	200 mm	8"	SUS 304
AH2225161825	1.6 mm	18 mm	250 mm	10"	SUS 304
AH2225182230	1.8 mm	22 mm	300 mm	12"	SUS 304
AH2225182235	1.8 mm	22 mm	350 mm	14"	SUS 304
AH2225182240	1.8 mm	22 mm	400 mm	16"	SUS 304
AH2225182245	1.8 mm	22 mm	450 mm	18"	SUS 304
AH2225202750	2.0 mm	27 mm	500 mm	20"	SUS 304
AH2225202755	2.0 mm	27 mm	550 mm	22"	SUS 304
AH2225202760	2.0 mm	27 mm	600 mm	24"	SUS 304
AH2225202765	2.0 mm	27 mm	650 mm	26"	SUS 304
AH2225202770	2.0 mm	27 mm	700 mm	28"	SUS 304



Code	Thickness	Channel	Length		Material
AH2230121520	1.2 mm	15 mm	200 mm	8"	SUS 304
AH2230121525	1.2 mm	15 mm	250 mm	10"	SUS 304
AH2230121530	1.2 mm	15 mm	300 mm	12"	SUS 304
AH2230121535	1.2 mm	15 mm	350 mm	14"	SUS 304



Trendy Hardware with Passion

Range 2
Aluminum Hardware Kits



www.domusitalya.com

info@domusitalya.com



TILT & TURN WINDOW SERIES - DROP IN UP



Code
AH1001LJ001
Complete Kit # 1

TILT & TURN WINDOW SERIES - HINGED & DROP OUT DOWN

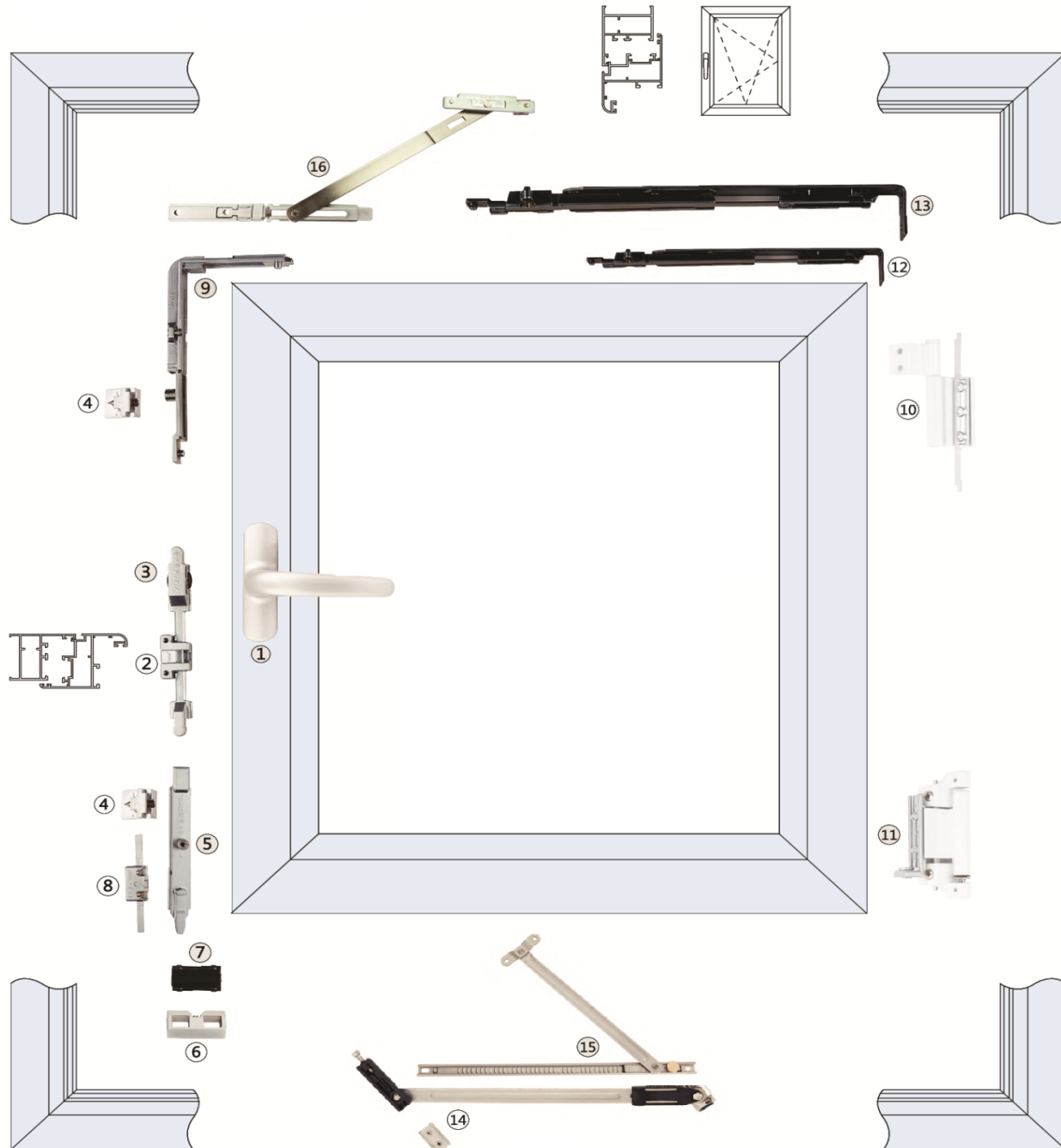

Code
AH1002LJDM0102
Complete Kit #2

TILT & TURN WINDOW SERIES

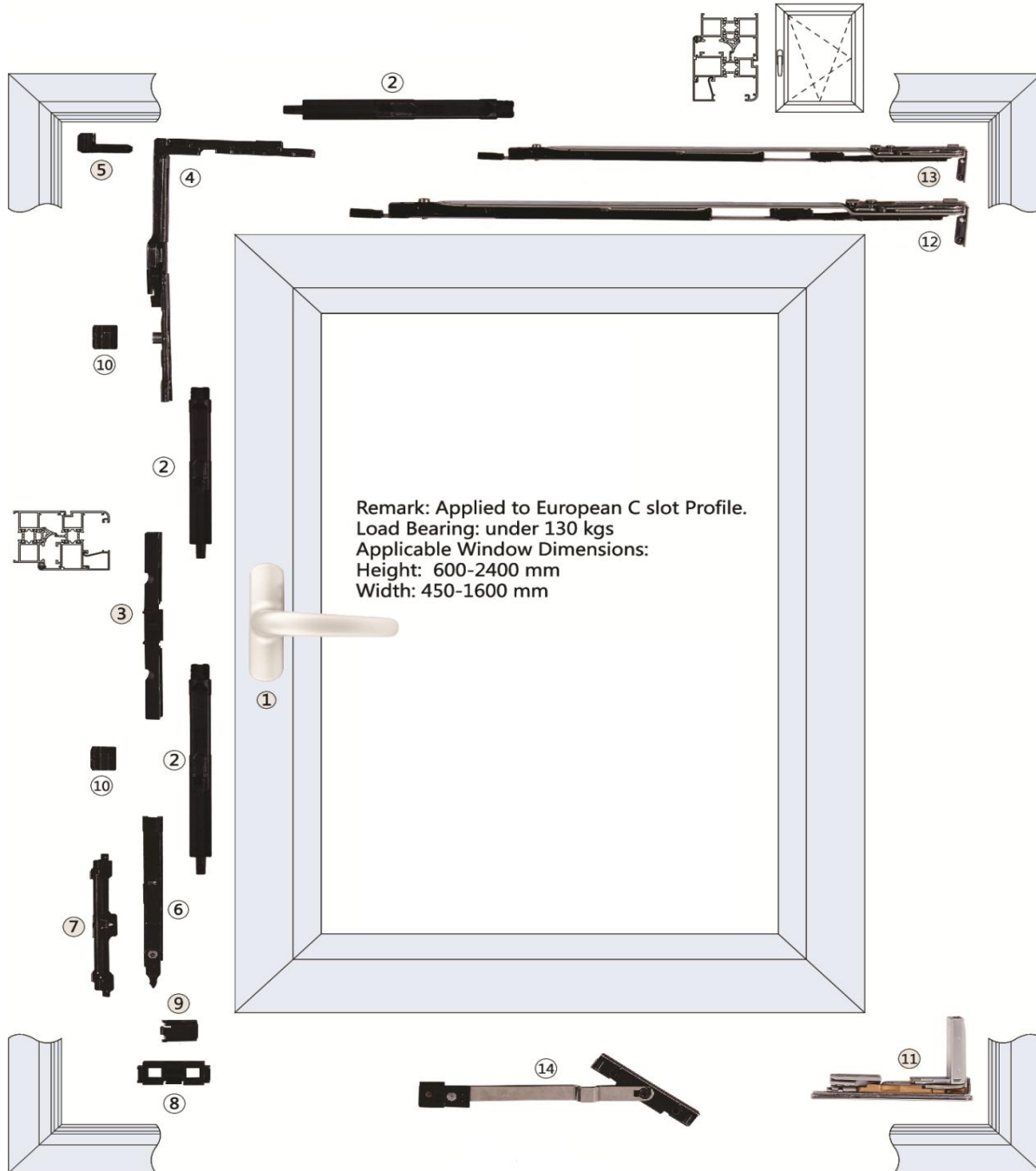

Code
AH1003LJNKND0809
Complete Kit # 3

TILT & TURN WINDOW SERIES

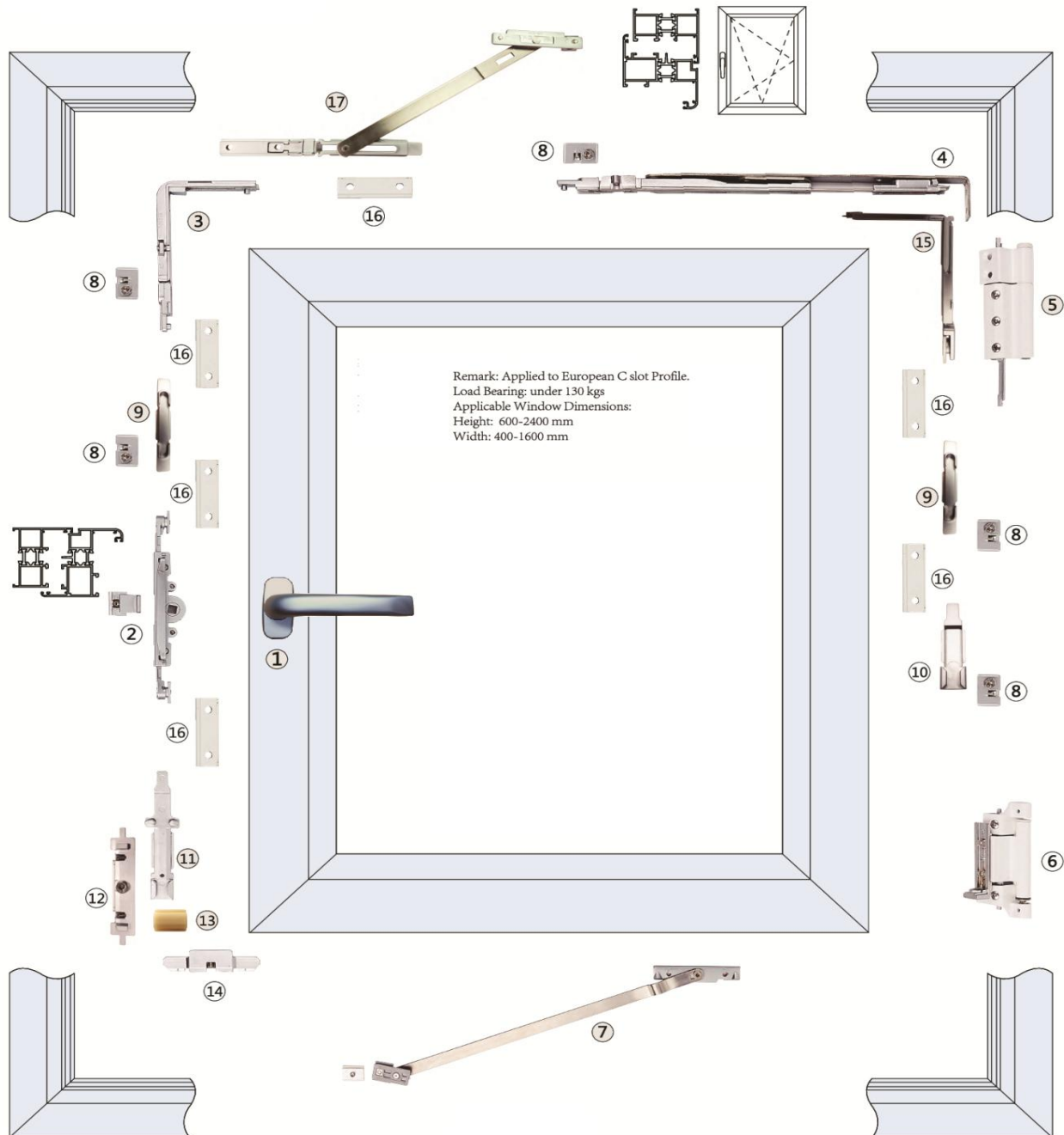

Code
AH1004LJNKND031
Complete Kit # 4

TILT & TURN WINDOW SERIES

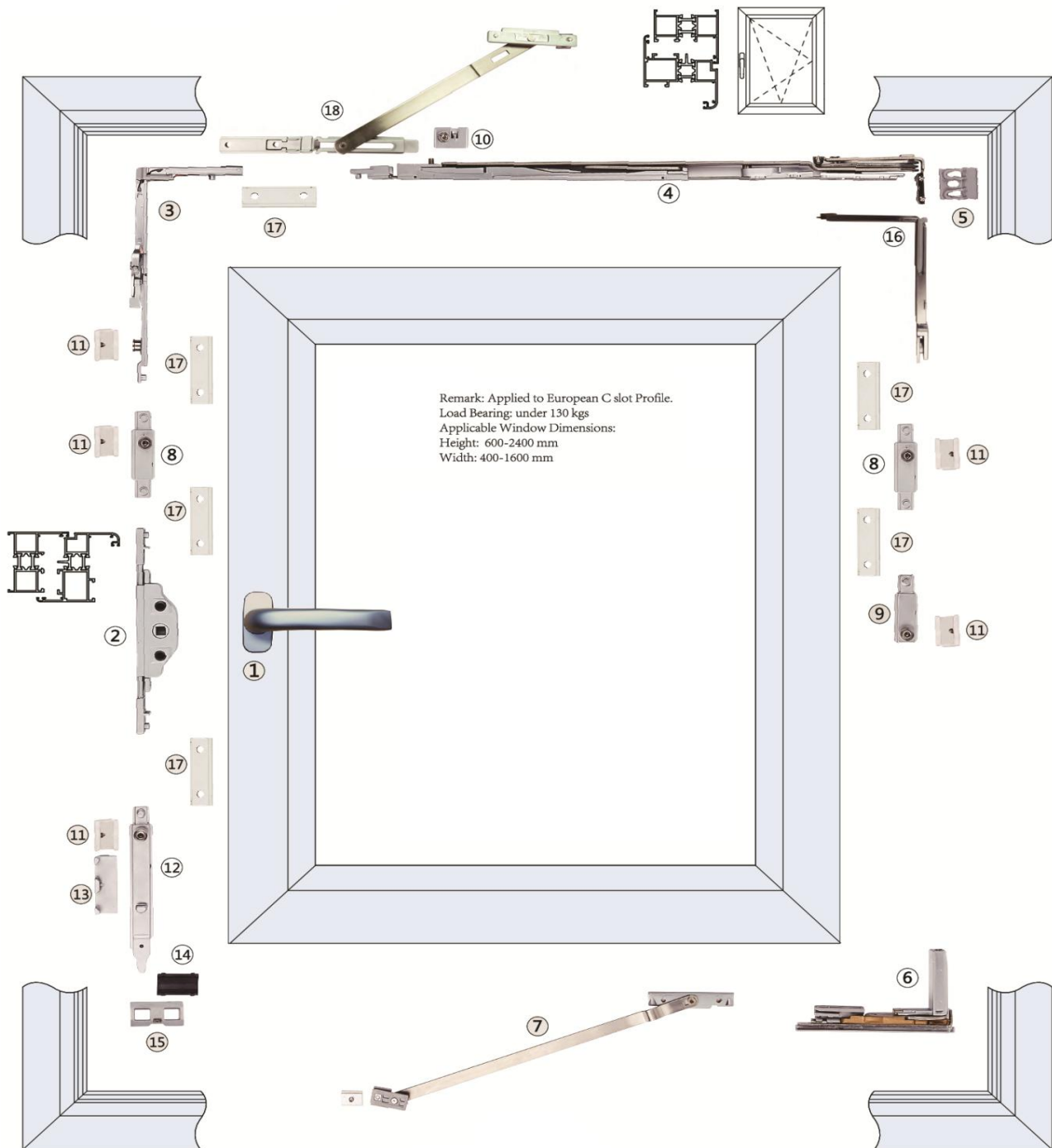

Code
AH1005LJNKND031-1
Complete Kit # 5

TILT & TURN WINDOW SERIES

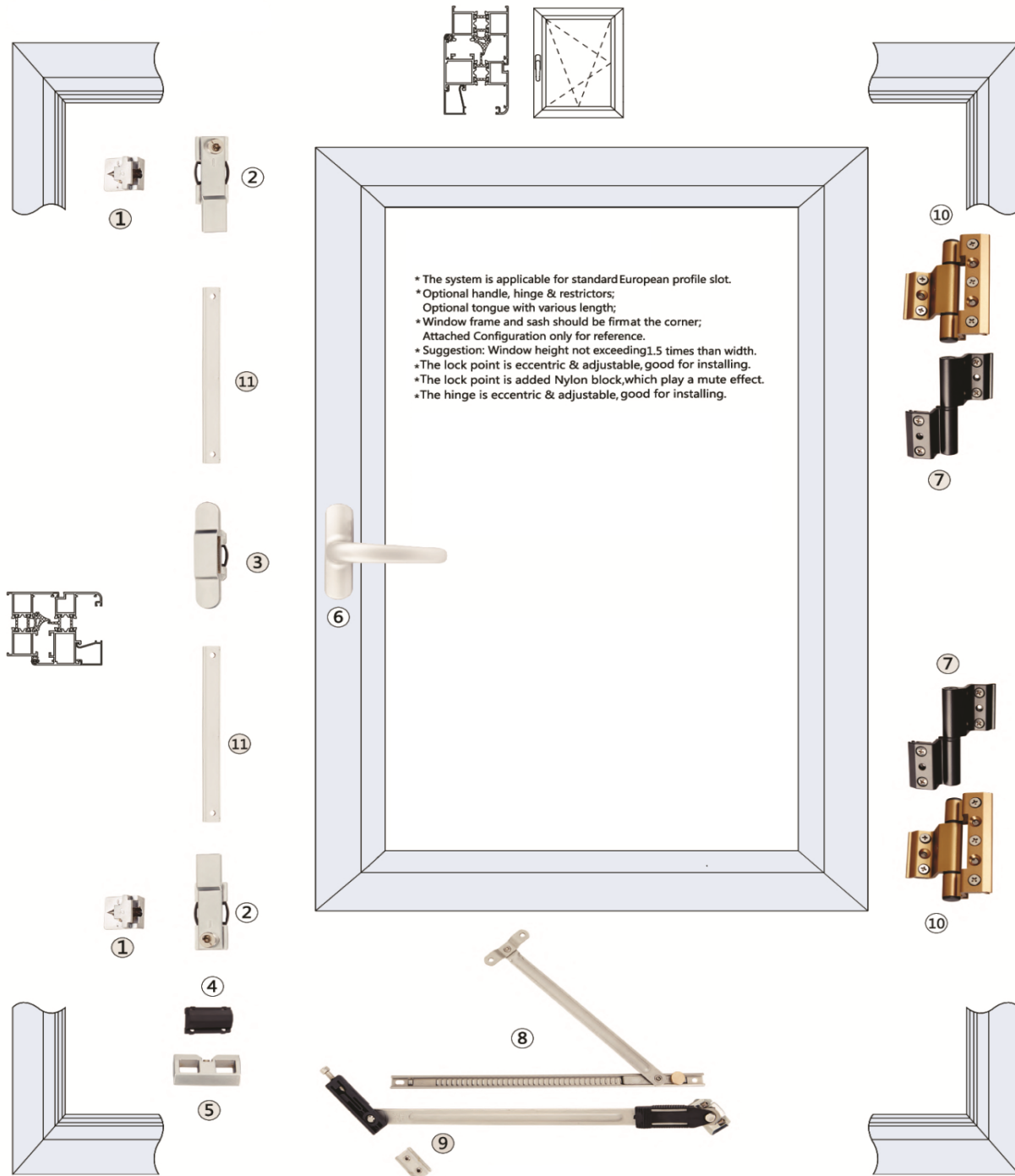

Code
AH1006LJNPKC01
Complete Kit # 6

TILT & TURN WINDOW SERIES

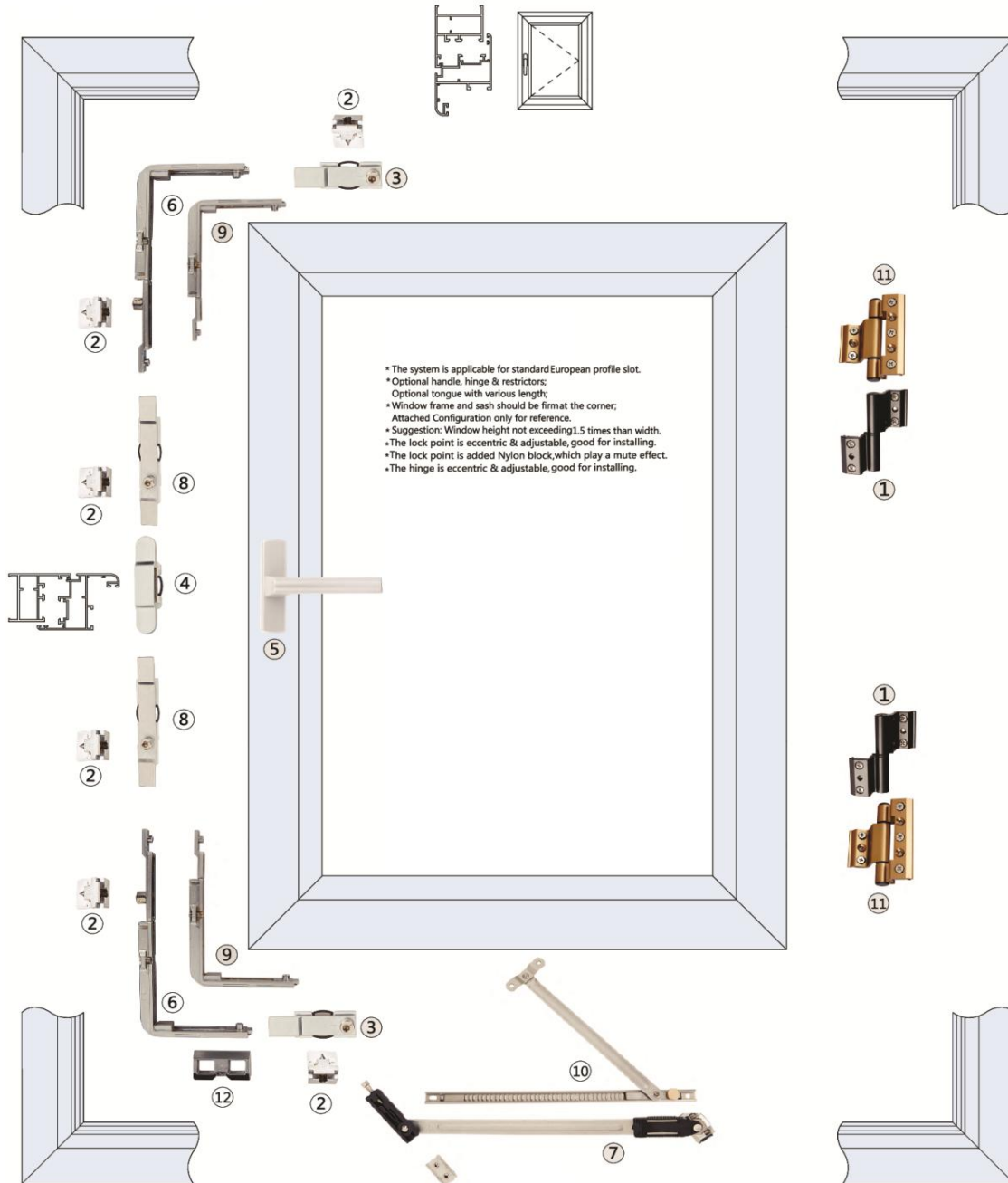

Code
AH1007LJNPKC02
Complete Kit #7

TILT & TURN WINDOW SERIES

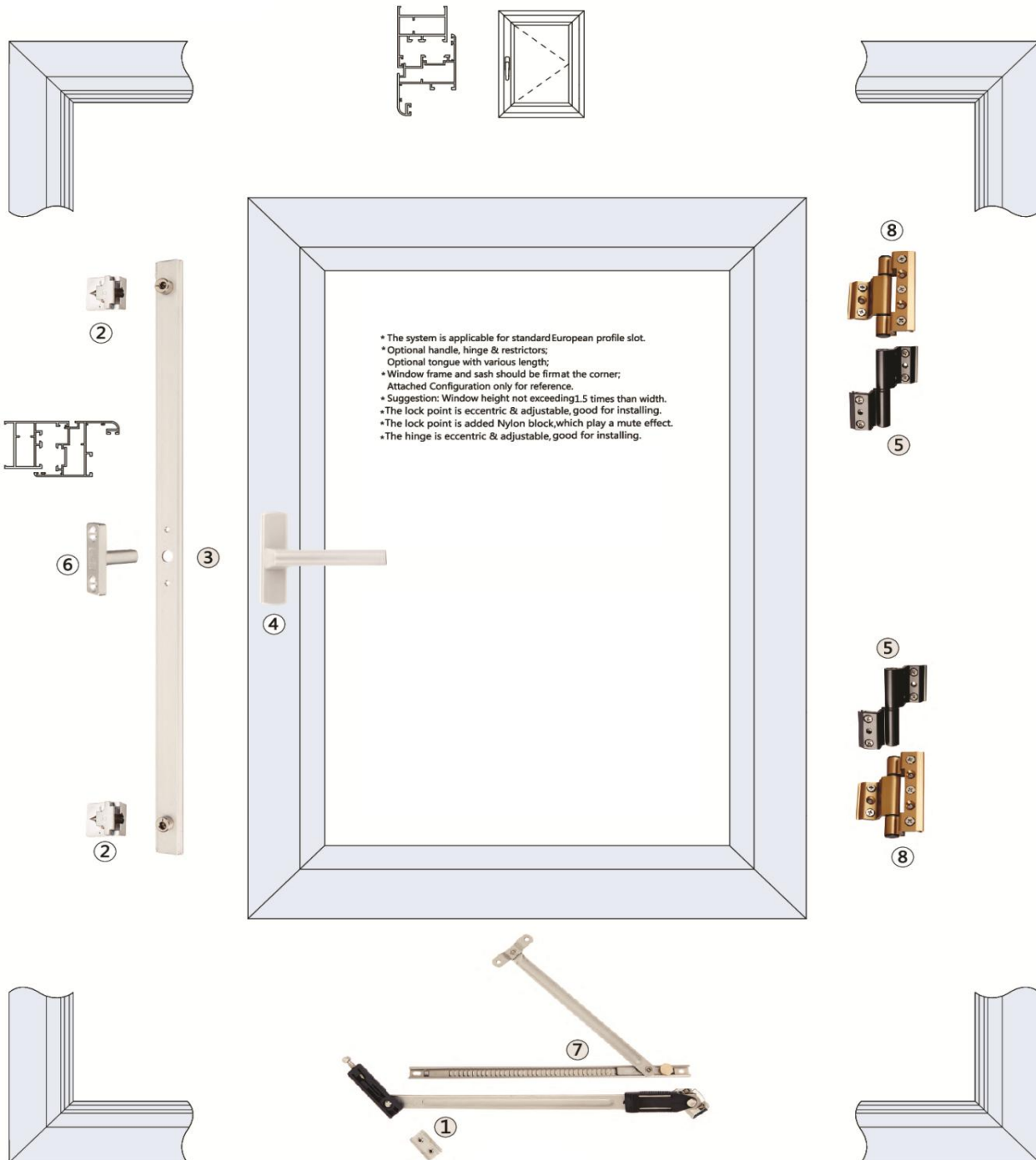

Code
AH1008LJNPKC03
Complete Kit # 8

TILT & TURN WINDOW SERIES

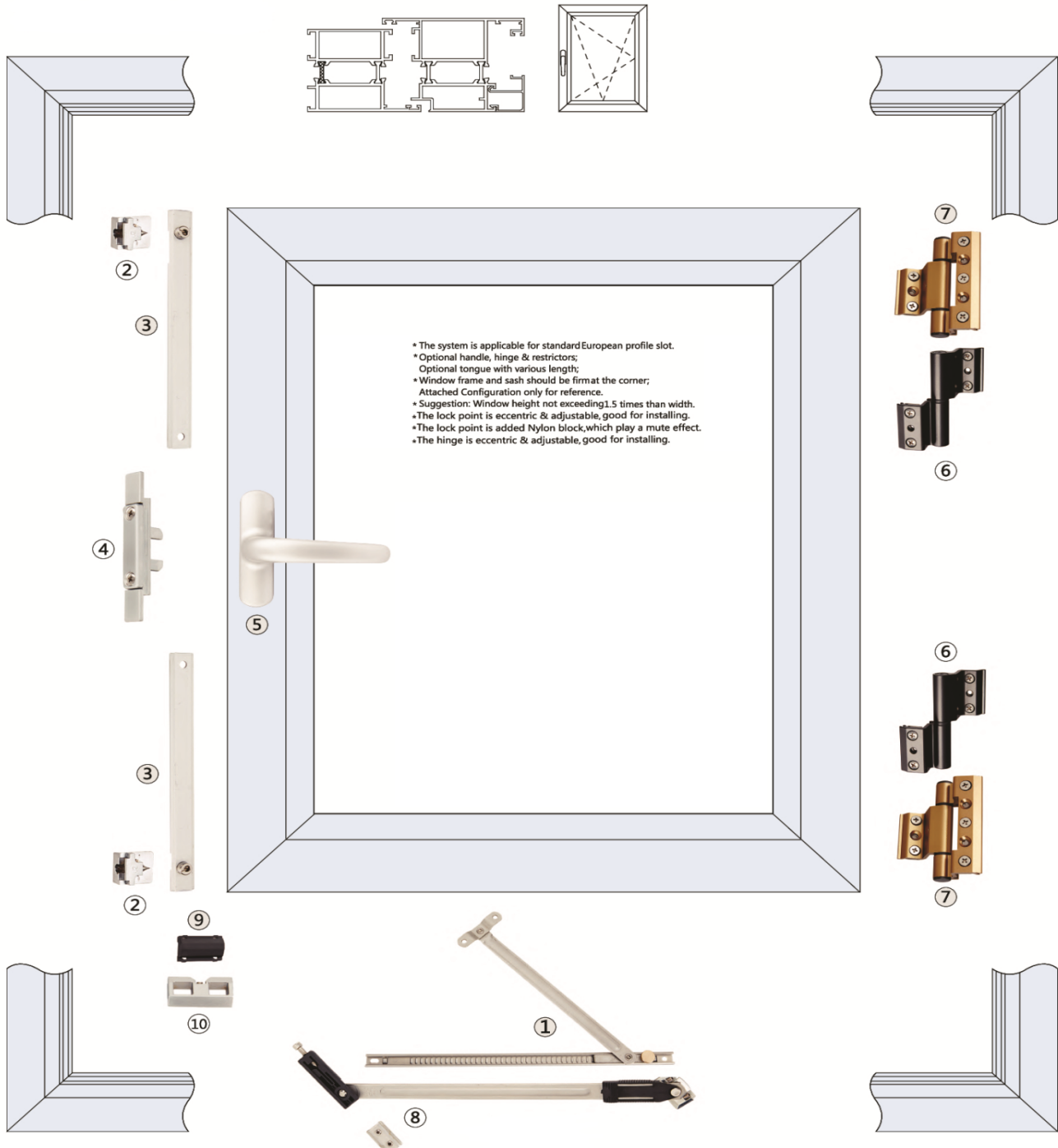

Code
AH1009LJWPKC
Complete Kit # 9

TILT & TURN WINDOW SERIES

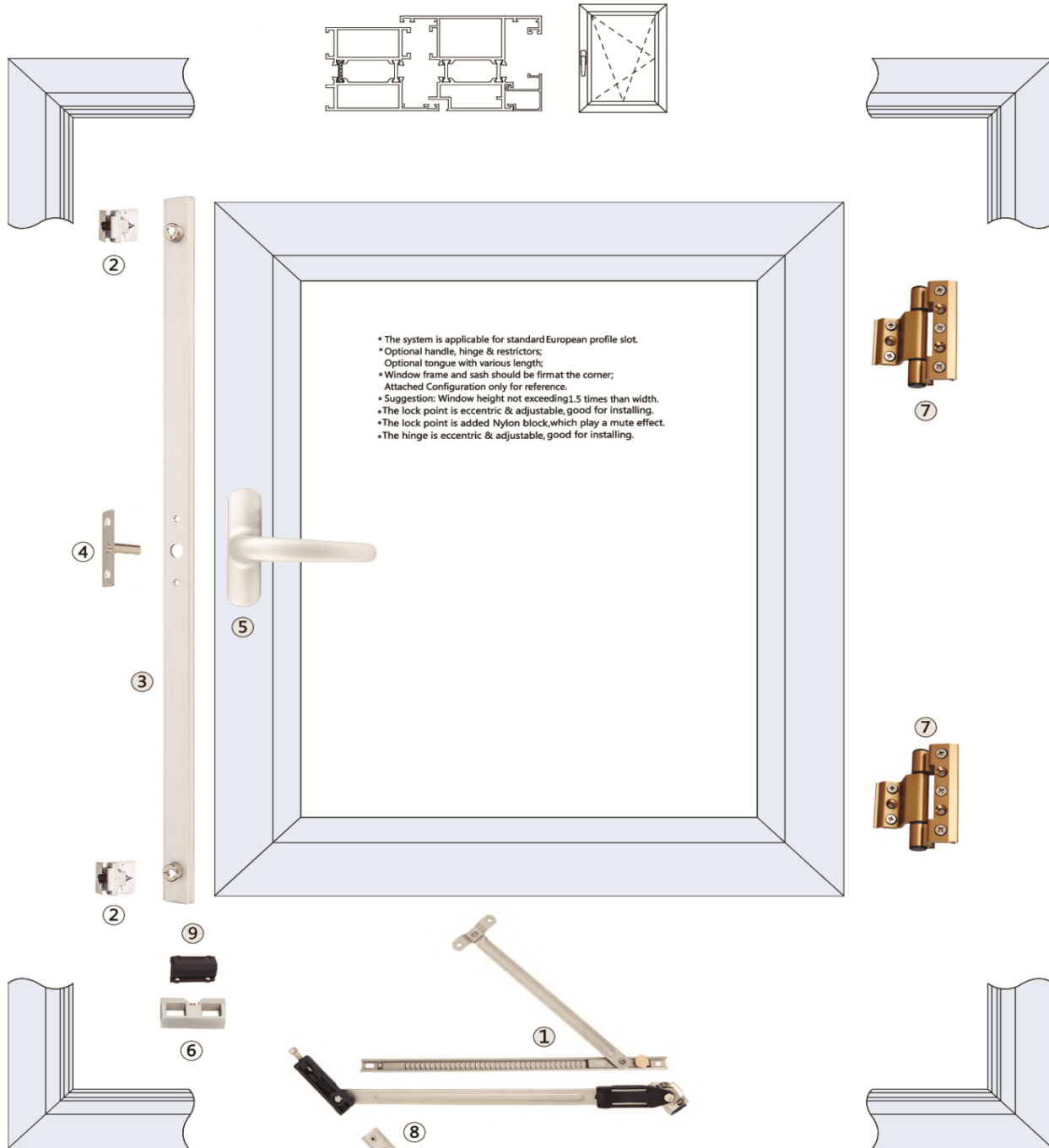

Code
AH1010LJWPKC01
Complete Kit # 10

TILT & TURN WINDOW SERIES

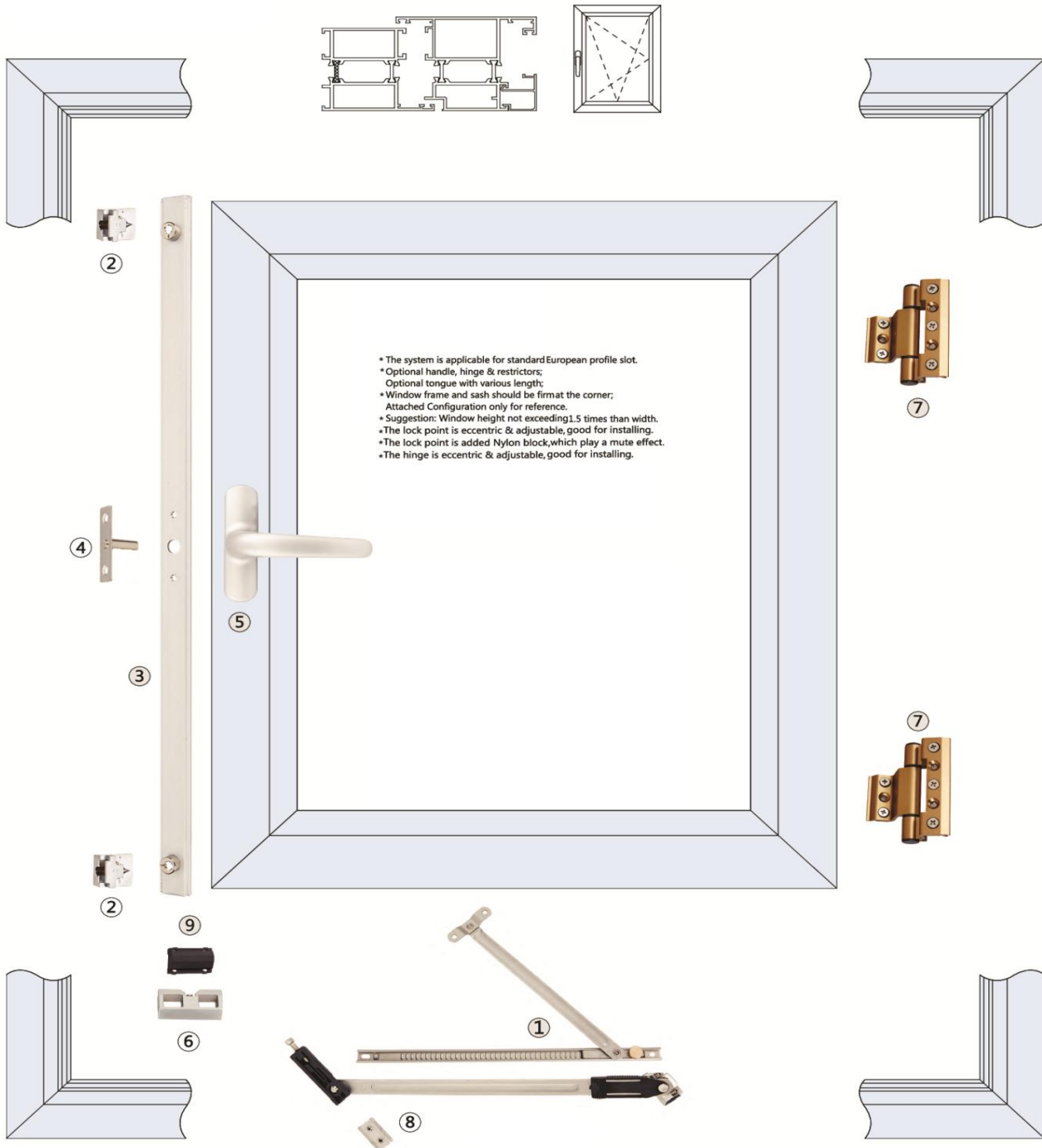

- * The system is applicable for standard European profile slot.
- * Optional handle, hinge & restrictors;
- * Optional tongue with various length;
- * Window frame and sash should be firm at the corner;
- * Attached Configuration only for reference.
- * Suggestion: Window height not exceeding 1.5 times than width.
- * The lock point is eccentric & adjustable, good for installing.
- * The lock point is added Nylon block, which play a mute effect.
- * The hinge is eccentric & adjustable, good for installing.

Code
AH1011LJWPKC02
Complete Kit # 11

TILT & TURN WINDOW SERIES

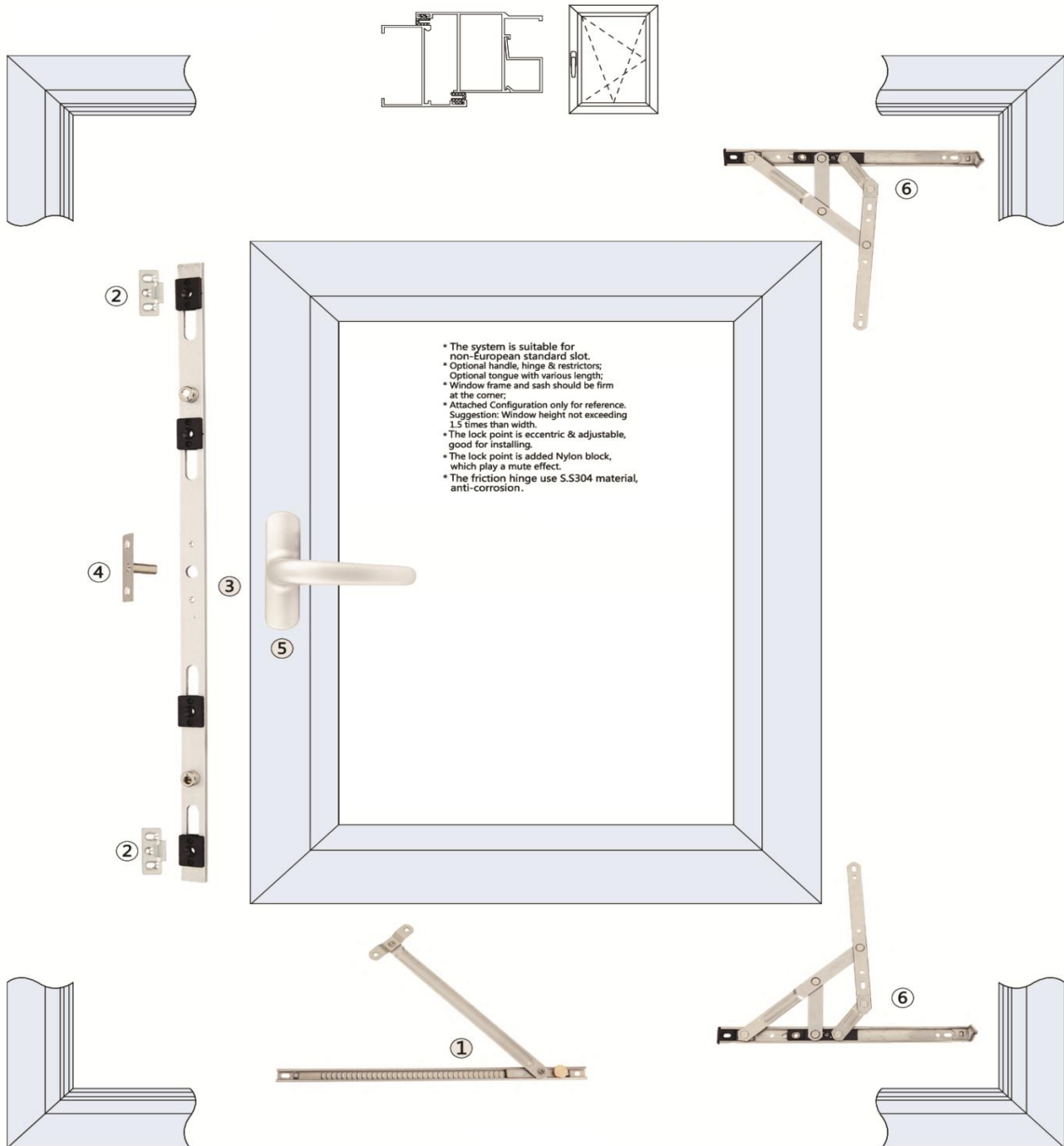

Code
AH1012LJWPKC03
Complete Kit # 12

TILT & TURN WINDOW SERIES

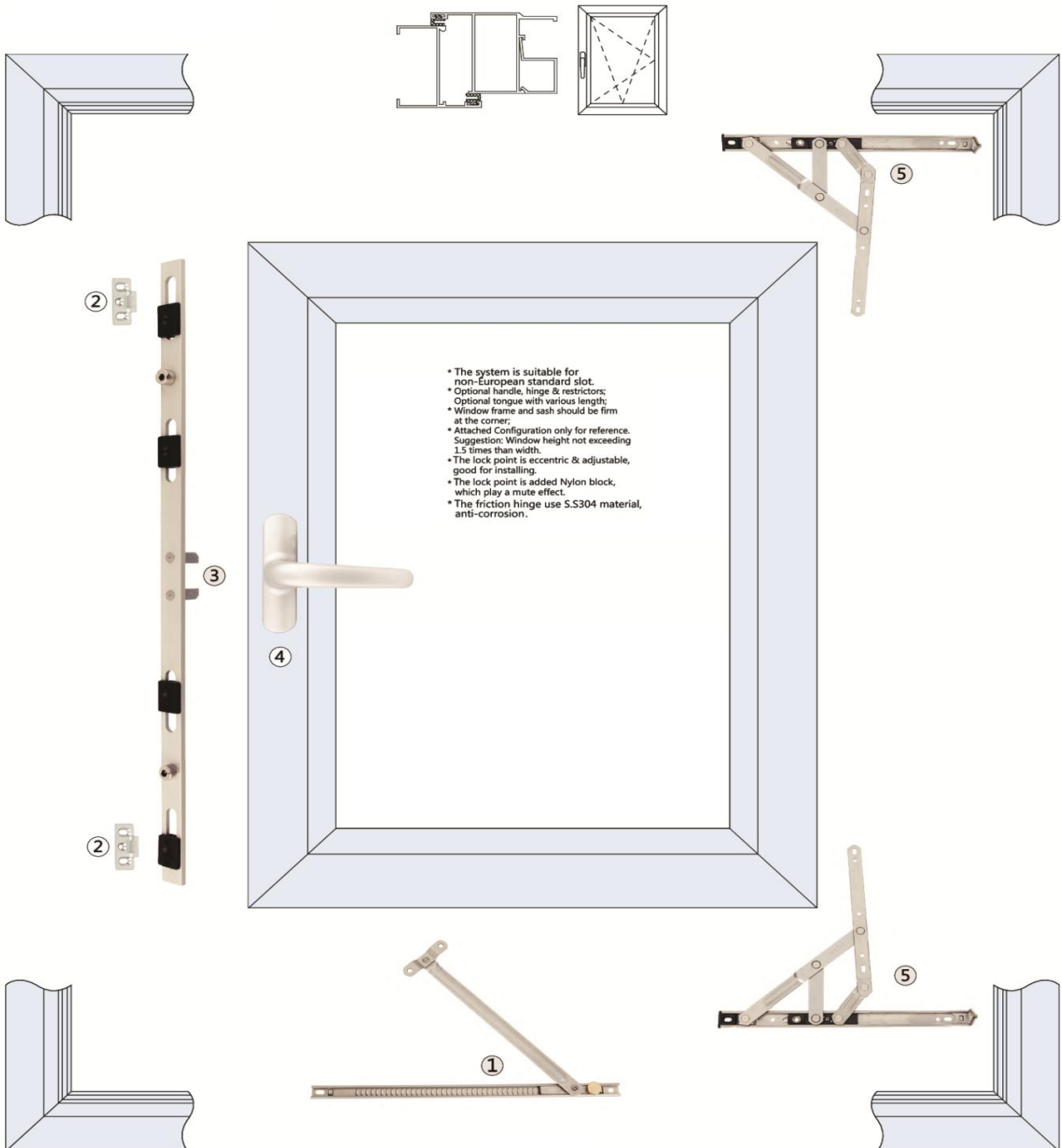

- The system is suitable for non-European standard slot.
- Optional handle, hinge & restrictors;
- Optional tongue with various length;
- Window frame and sash should be firm at the corner;
- Attached Configuration only for reference. Suggestion: Window height not exceeding 1.5 times than width.
- The lock point is eccentric & adjustable, good for installing.
- The lock point is added Nylon block, which play a mute effect.
- The friction hinge use S.S304 material, anti-corrosion.

Code
AH1013LJWPKC04
Complete Kit # 13

TILT & TURN WINDOW SERIES

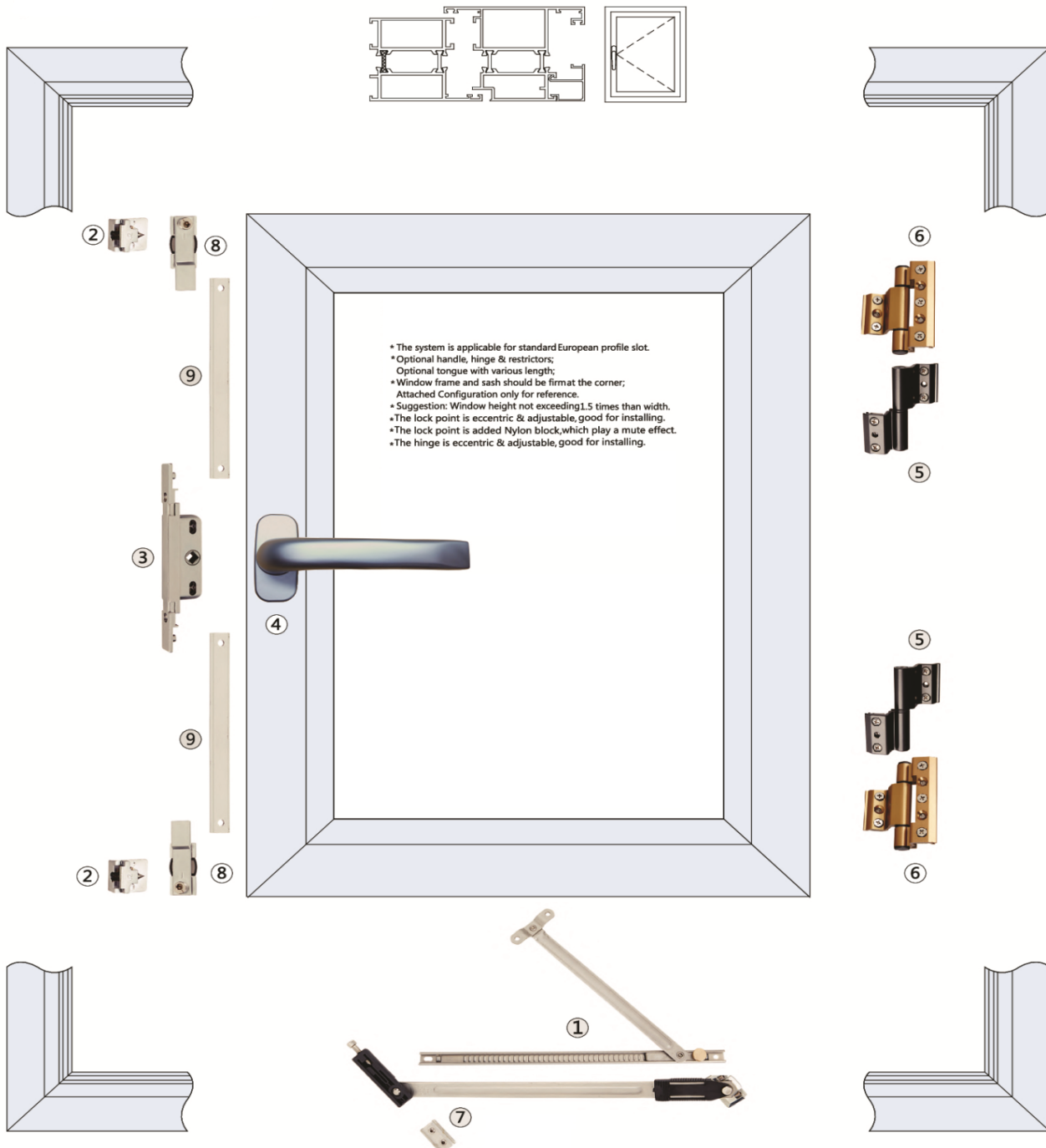

Code
AH1014LJWPKC05
Complete Kit # 14

AWNING WINDOW SERIES

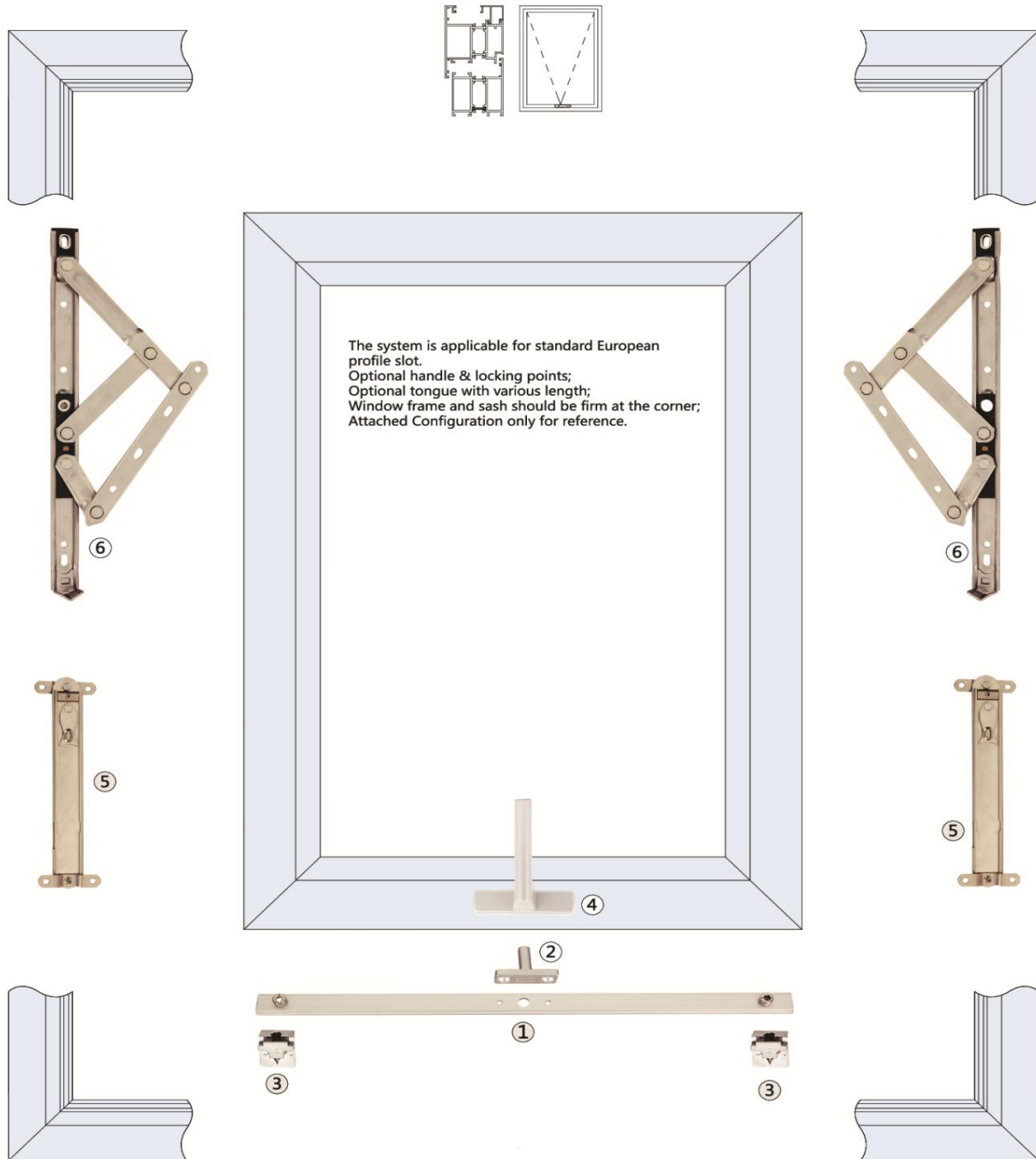

Code
AH1015LJXXC01
Complete Kit # 15

AWNING WINDOW SERIES

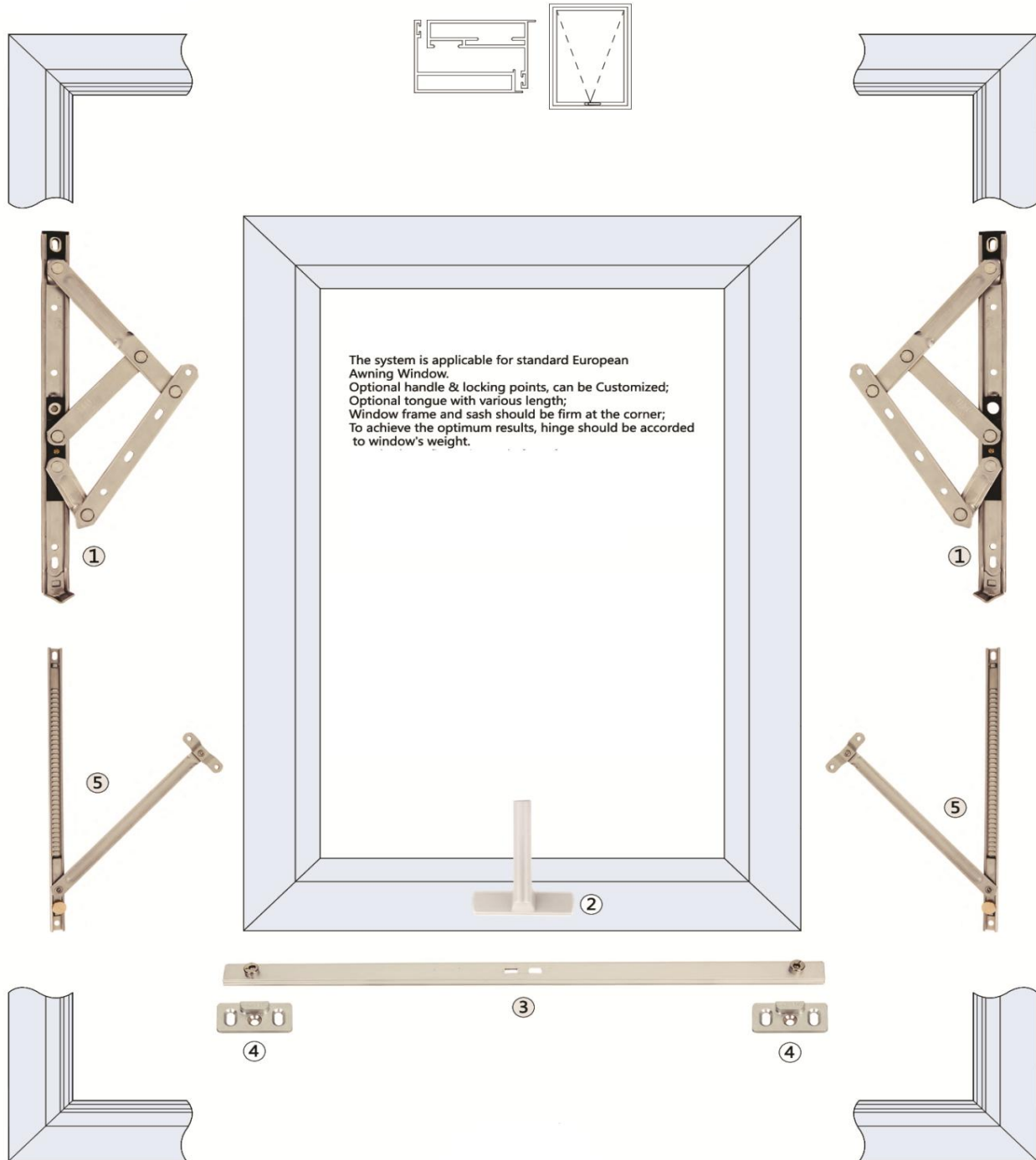

Code
AH1016LJXXC02
Complete Kit # 16

AWNING WINDOW SERIES

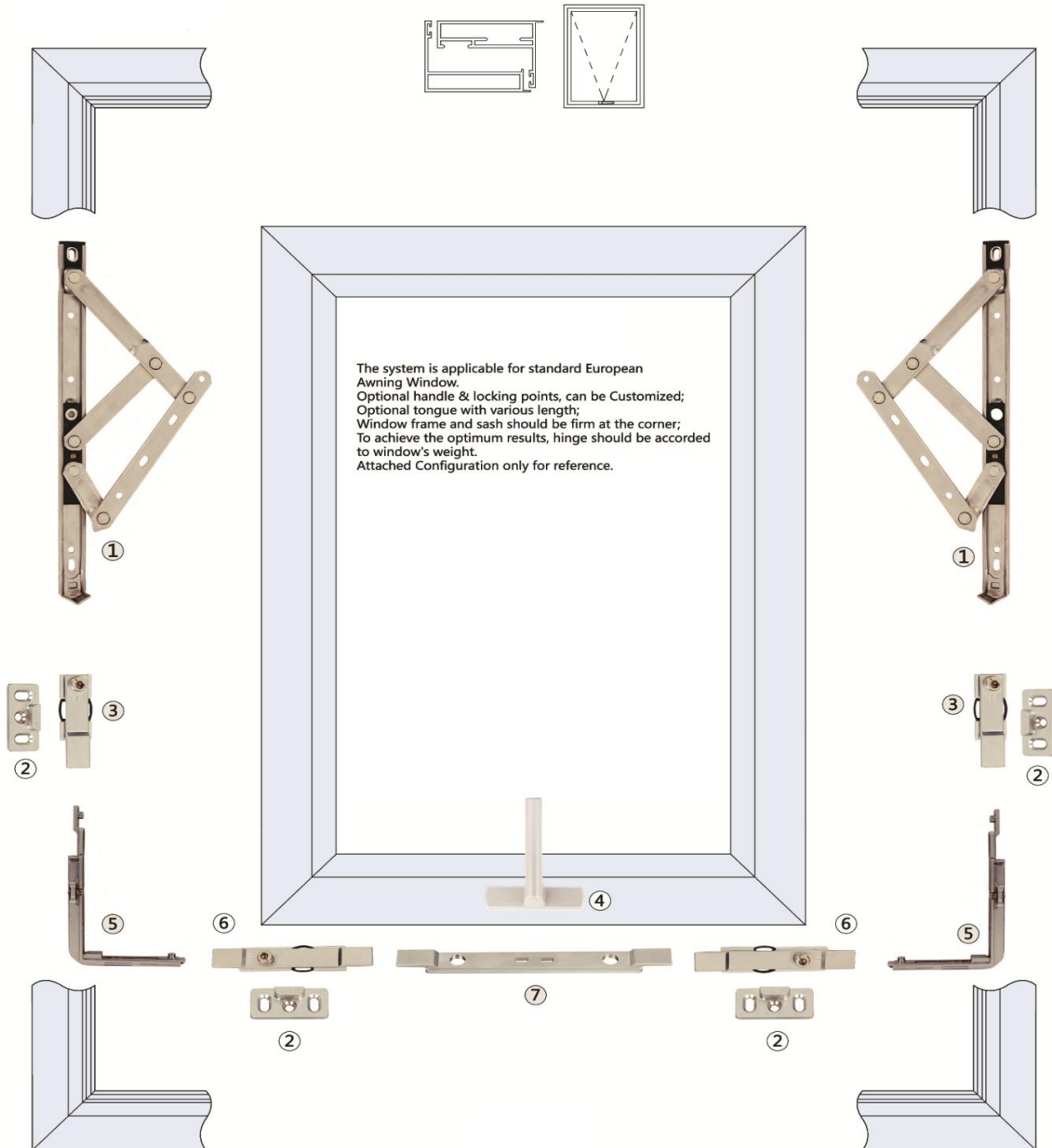

Code
AH1017LJXXC03
Complete Kit # 17

HINGED DOOR SERIES

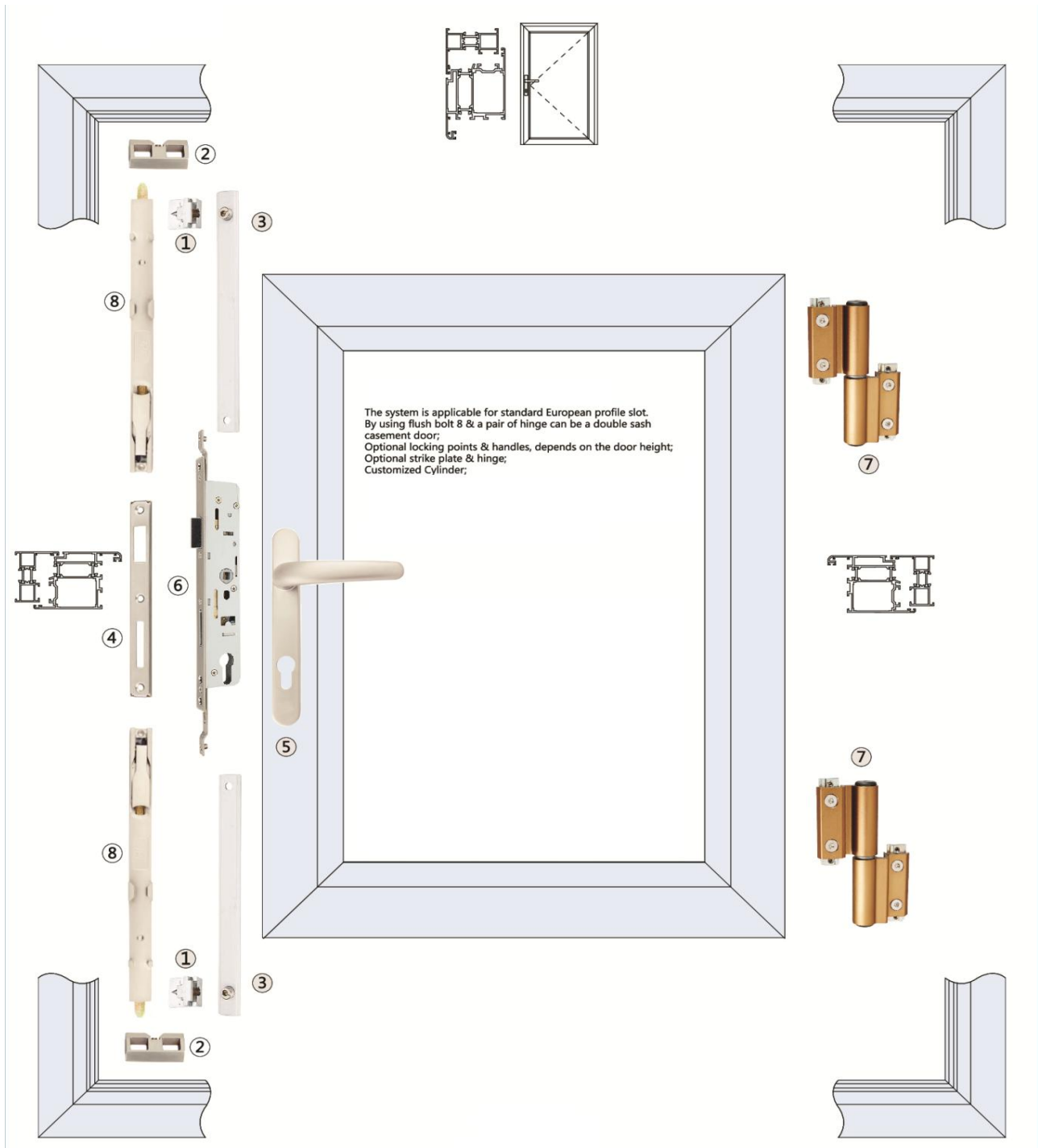

Code
AH1018LJPKM01
Complete Kit # 18

HINGED DOOR SERIES

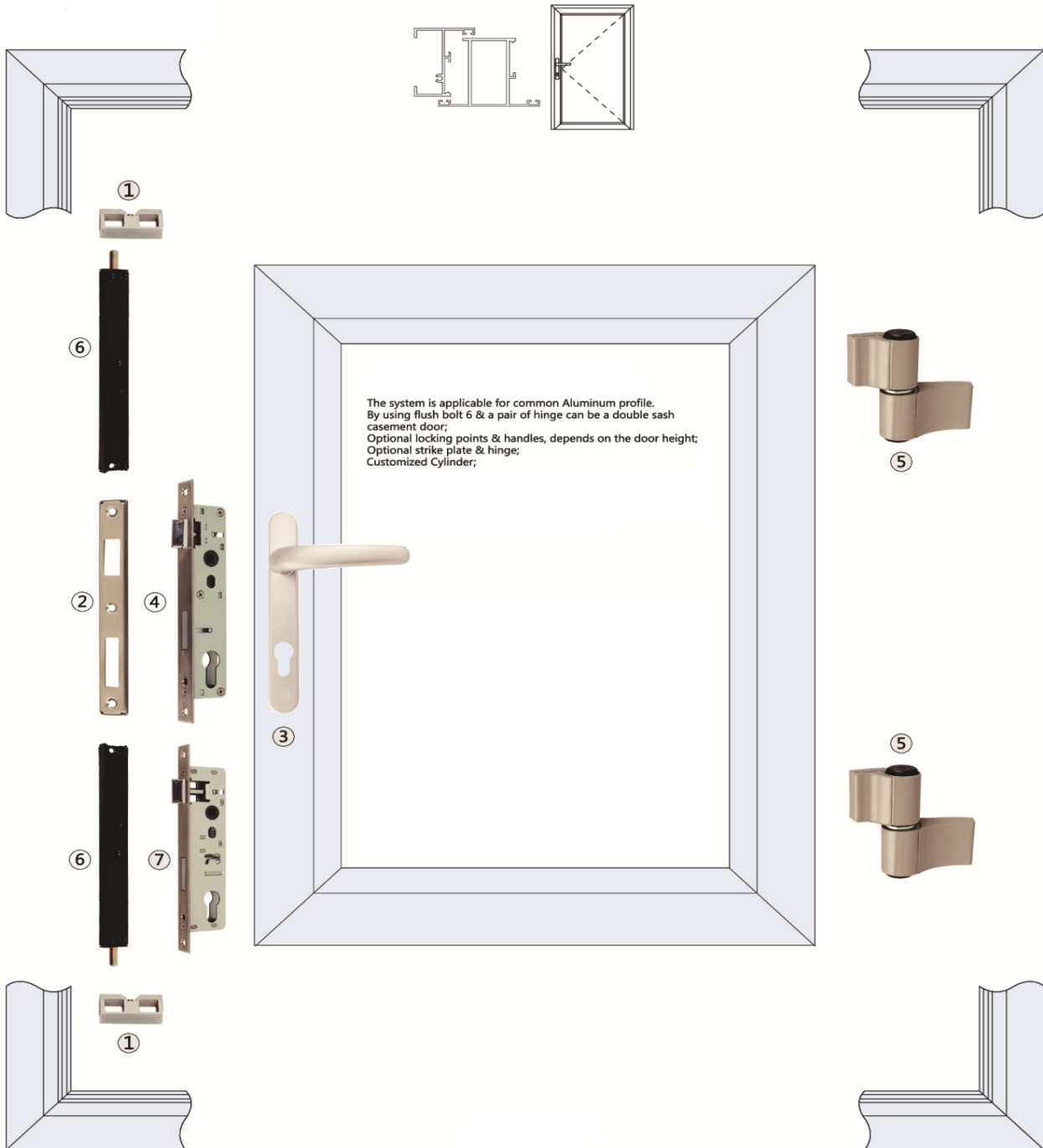

Code
AH1019LJPKML02
Complete Kit # 19

LIFTING & SLIDING DOOR SERIES

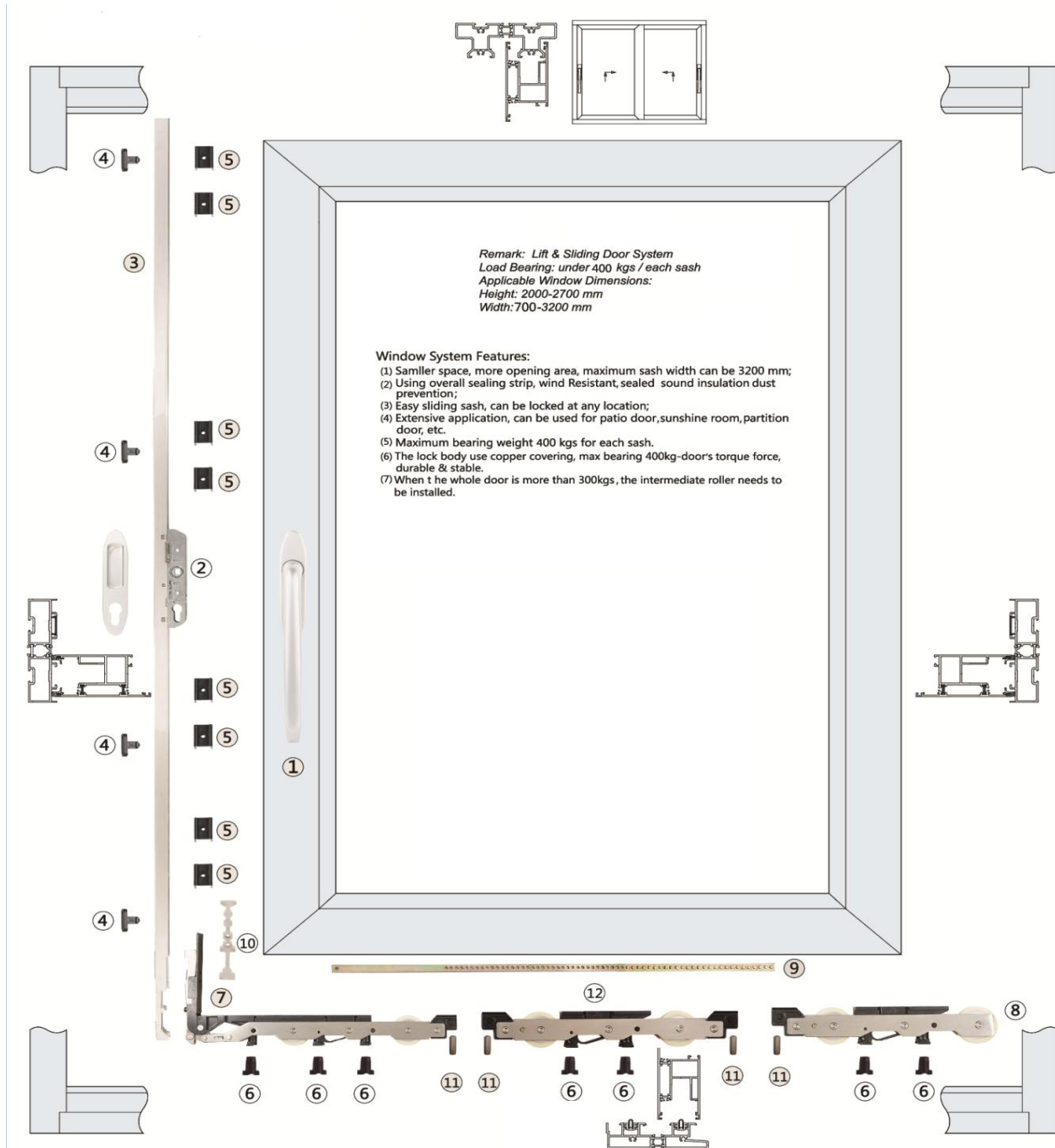

Code
AH1020LJTSTLM01
Complete Kit # 20

LIFTING & SLIDING DOOR SERIES

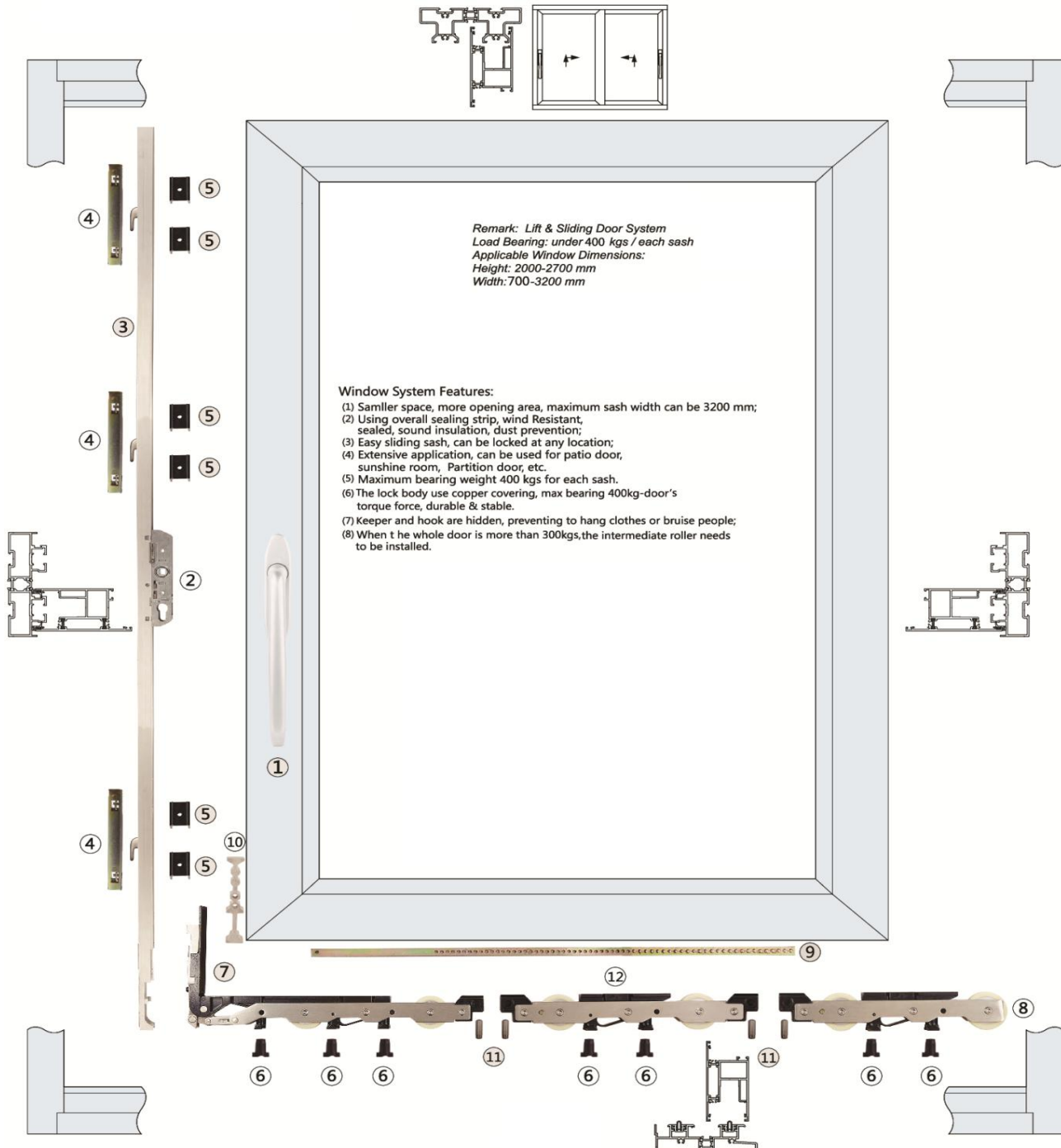

Code
AH1021LJTSTLM02
Complete Kit # 21

SLIDING DOOR SERIES

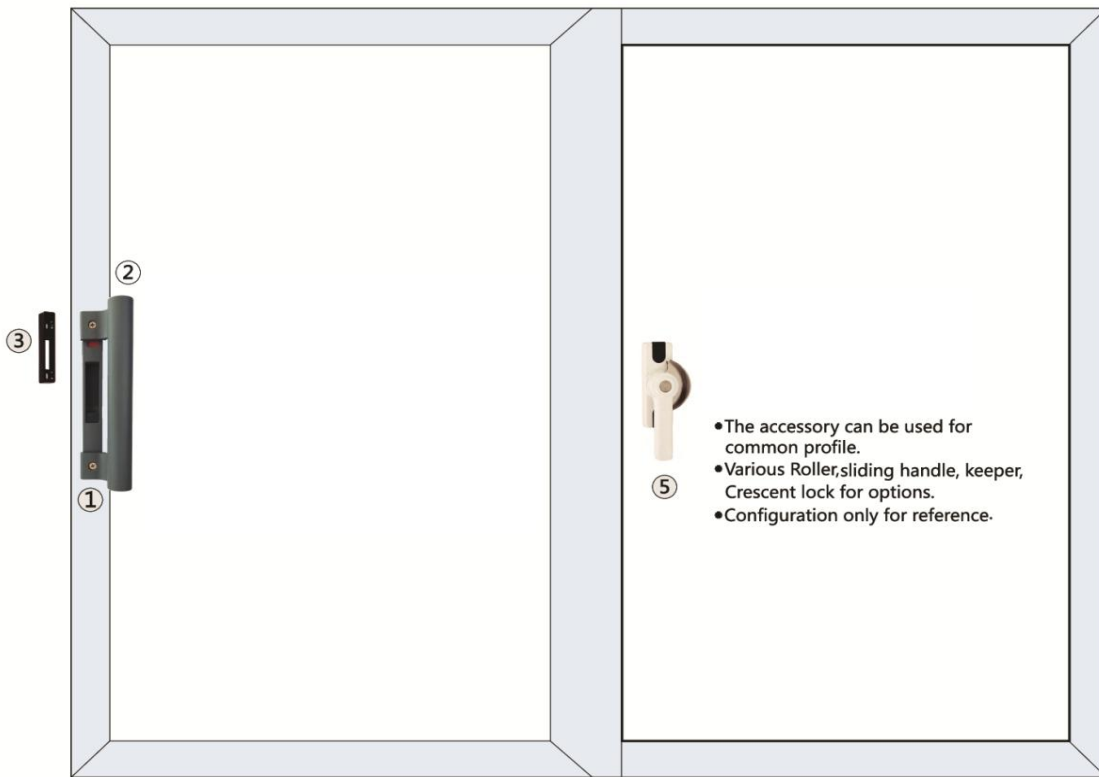
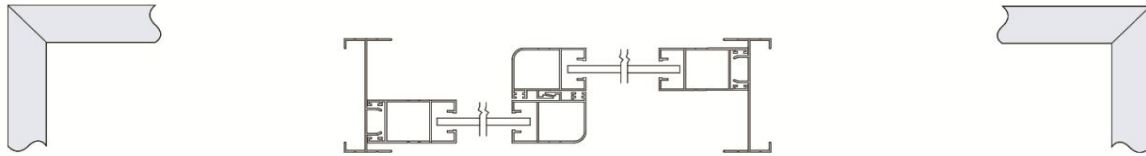

Code
AH1022LJWSL01
Complete Kit # 22



Trendy Hardware with Passion

Range 3
ALUMINUM HANDLES



www.domusitalya.com

info@domusitalya.com





Trendy Hardware with Passion

Part 1
DOOR LEVER HANDLES



www.domusitalya.com

info@domusitalya.com

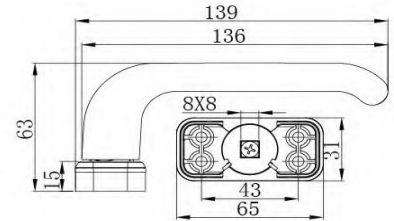

Galeon^{by} D.I.
Made In China

LEVER DOOR HANDLES

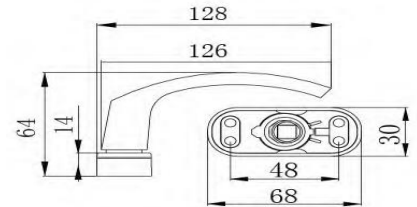

Code

AH850WS1090



Code

AH851WS1470

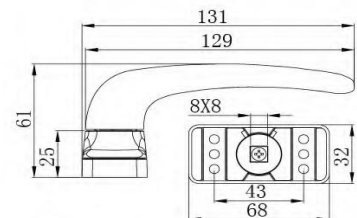

Code

AH852WS1040

LEVER DOOR HANDLES

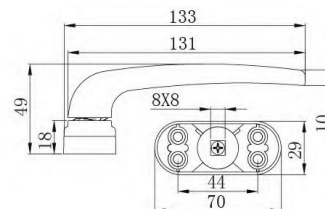

Code
AH854WS1170

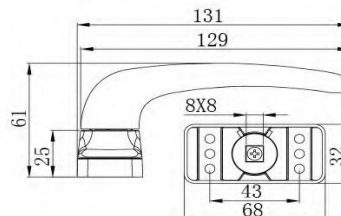

Code
AH853TYA19B

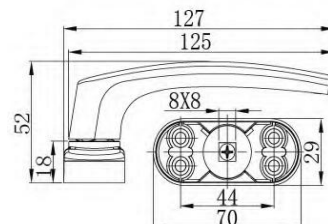

Code
AH855WS1180

LEVER DOOR HANDLES

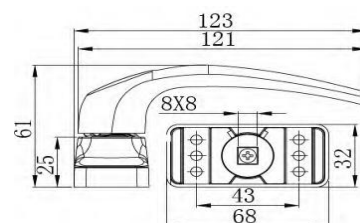

Code
AH857WS1050

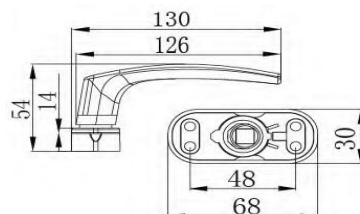

Code
AH865WS1471

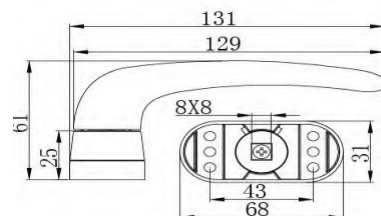

Code
AH858WS1061

LEVER DOOR HANDLES

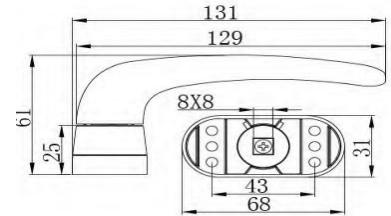

Code
AH861TY20C

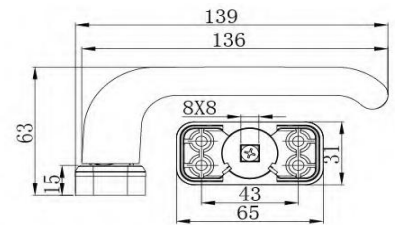

Code
AH871TY19A

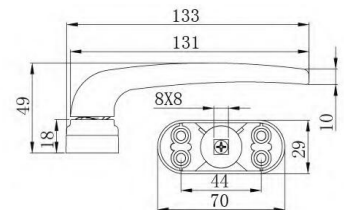

Code
AH873TY19



Trendy Hardware with Passion

Part 2
DOOR PULL HANDLES



www.domusitalya.com

info@domusitalya.com



DOOR PULL HANDLES



Code
AH911WS1460



Code
AH912WS1510



Code
AH913WS1400



Code
AH914WS1390

DOOR PULL HANDLES

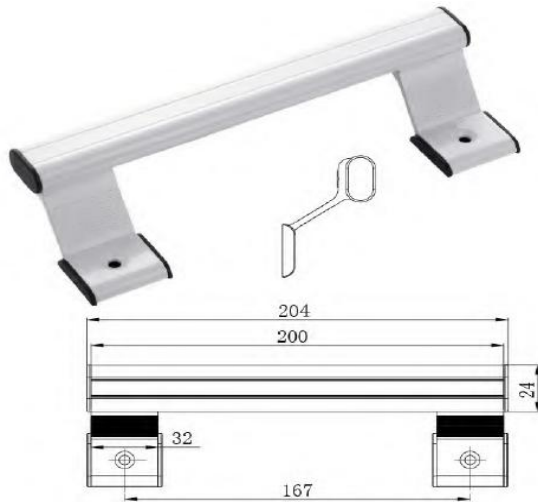

Code
AH915WS1300

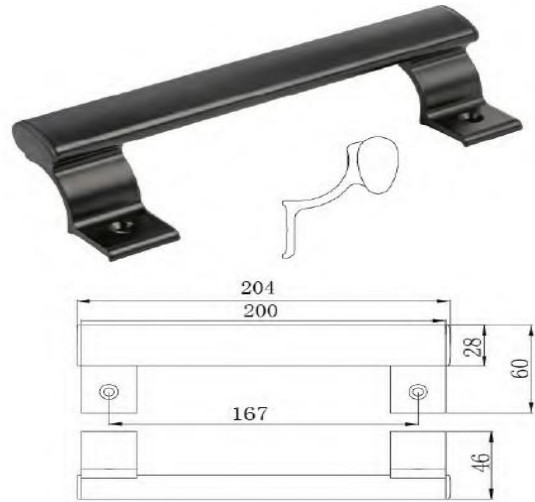

Code
AH916WS1320



Code
AH917WS1350

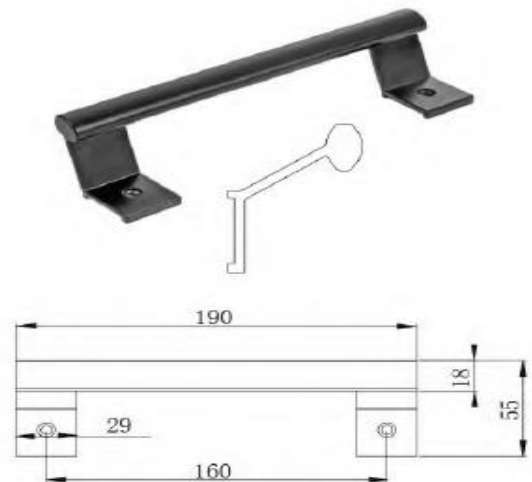

Code
AH918WS1520

DOOR PULL HANDLES

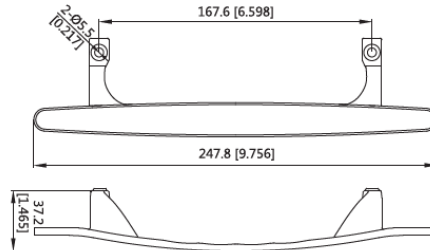

Code
AH919JSLSA01

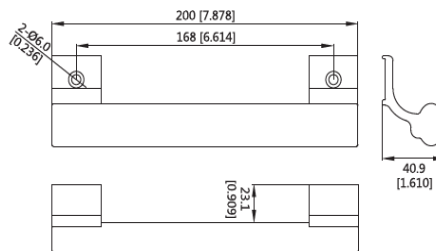

Code
AH920JSLSA02

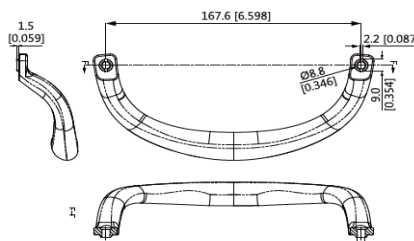

Code
AH922JSLSA06

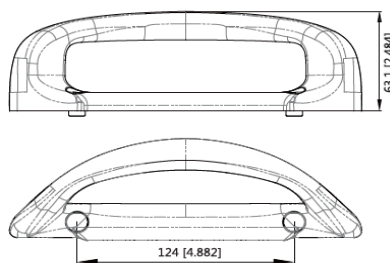

Code
AH921JSLSB06

DOOR PULL HANDLES



Code
AH924TYA48
214 mm



Code
AH925TYA49A
198 mm



Code
AH926TY56
255 mm



Code
AH927TYA48B
204 mm



Code
AH928TYA47
283 mm



Code
AH929TYA49B
198 mm



Trendy Hardware with Passion

Part 3
WINDOW HANDLES



www.domusitalya.com

info@domusitalya.com

Galeon^{by} D.I.
Made In China

WINDOW HANDLES

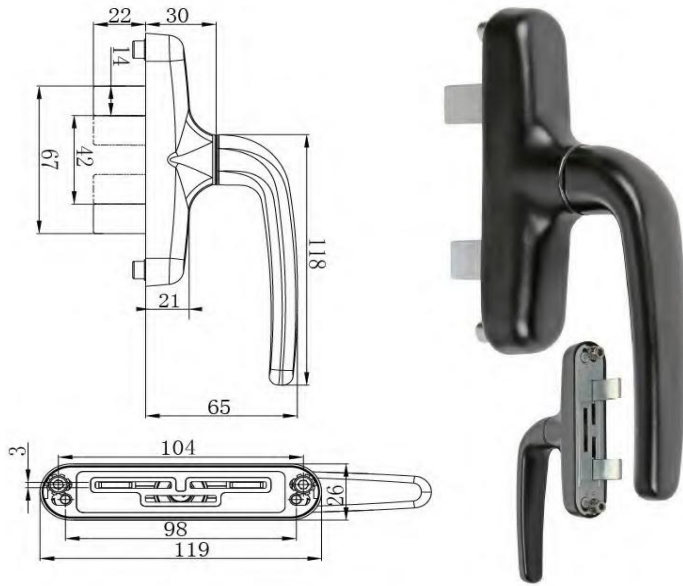

Code
AH901WS2041

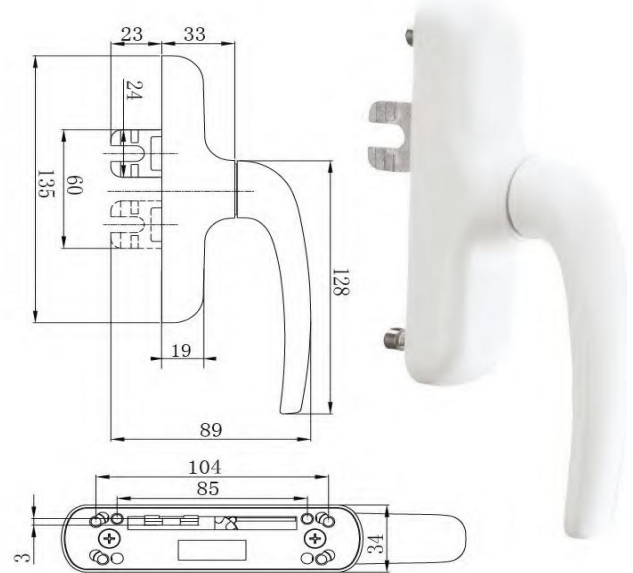

Code
AH902WS2021



Code
AH903WS2502



Code
AH904WS2530

Finishes :

MILD - ANODIZED - RAL COLORS - WOOD GRAINS

WINDOW HANDLES



Code
AH925WS2480

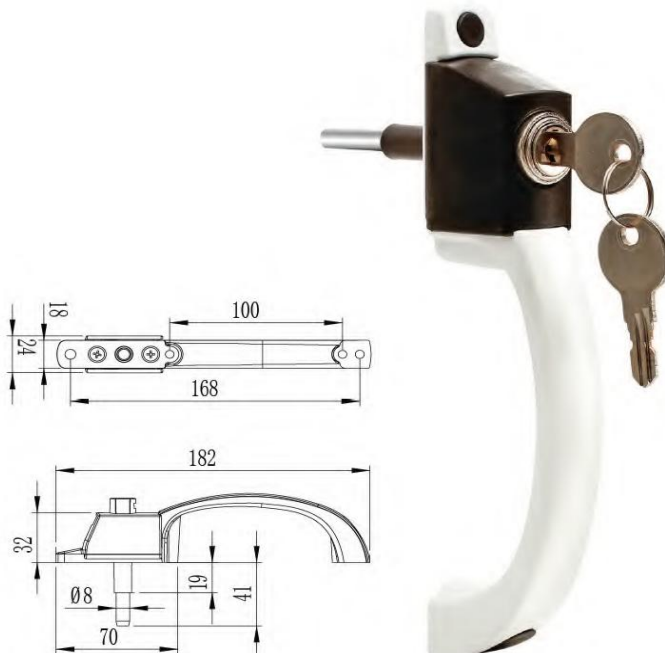

Code
AH926WS2480W

Finishes :

MILD - ANODIZED - RAL COLORS - WOOD GRAINS

WINDOW HANDLES



Code
AH938WS2351

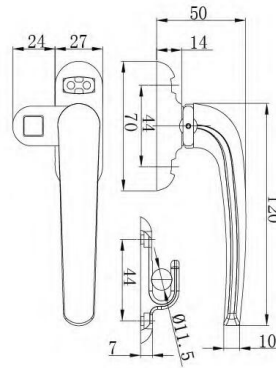

Code
AH947WS2170

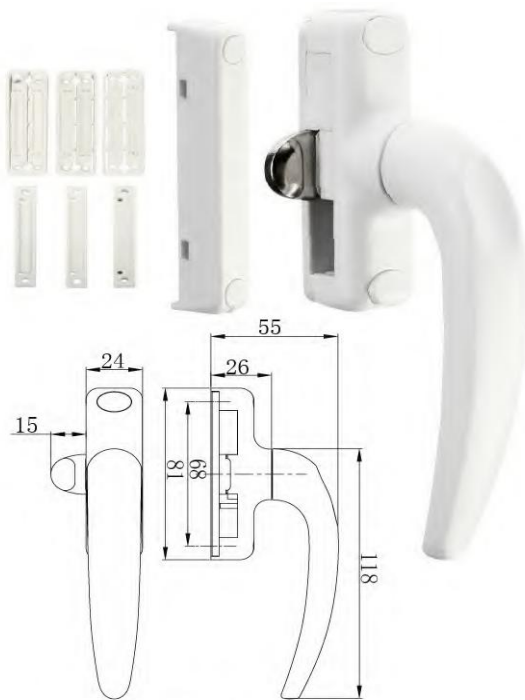

Code
AH932WS2350

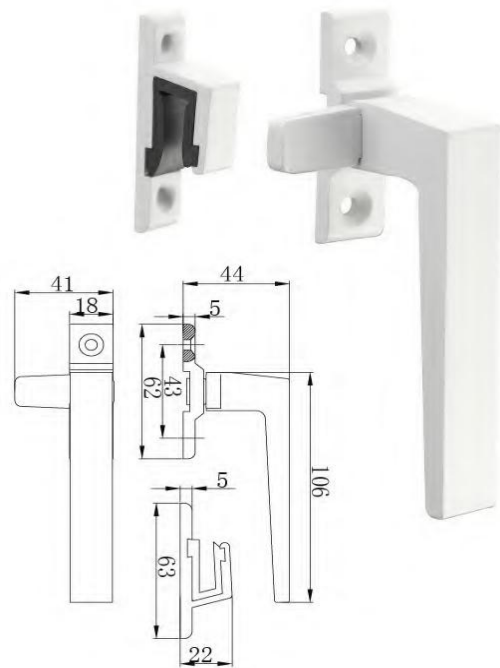

Code
AH942WS2460

WINDOW LATCHES

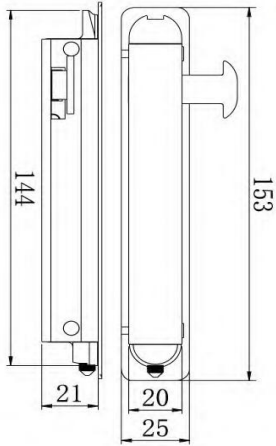

Code
AH725KG201B



Code
AH728KG201C

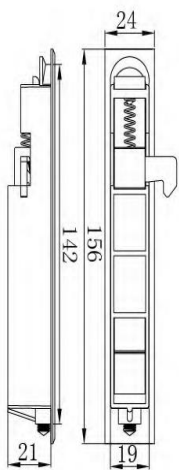

Code
AH742WS3130

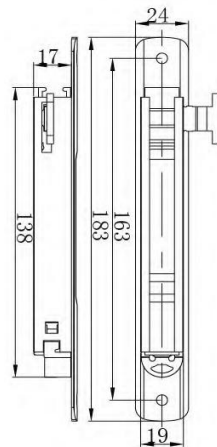

Code
AH748WS3270



Trendy Hardware with Passion

Range 4
Aluminum Door Locks



www.domusitalya.com

info@domusitalya.com



ALUMINUM DOOR LOCKS with CYLINDERS



Code	Backset
ALDL0018516	16 mm
ALDL0018520	20 mm
ALDL0018525	25 mm
ALDL0018530	30 mm

Code	Backset
ALDL0028516	16 mm
ALDL0028520	20 mm
ALDL0028525	25 mm
ALDL0028530	30 mm

ALUMINUM DOOR LOCKS with CYLINDERS



Code	Backset
ALDL0038516	16 mm
ALDL0038520	20 mm
ALDL0038525	25 mm
ALDL0038530	30 mm

Code	Backset
ALDL0048516	16 mm
ALDL0048520	20 mm
ALDL0048525	25 mm
ALDL0048530	30 mm

ALUMINUM DOOR LOCKS with CYLINDERS



Code	Backset
ALDL0058516	16 mm
ALDL0058520	20 mm
ALDL0058525	25 mm
ALDL0058530	30 mm

Code	Backset
ALDL0068516	16 mm
ALDL0068520	20 mm
ALDL0068525	25 mm
ALDL0068530	30 mm

ALUMINUM DOOR LOCKS with CYLINDERS

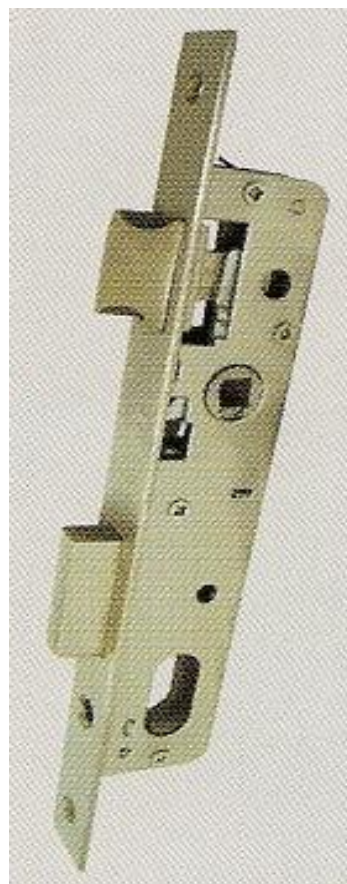
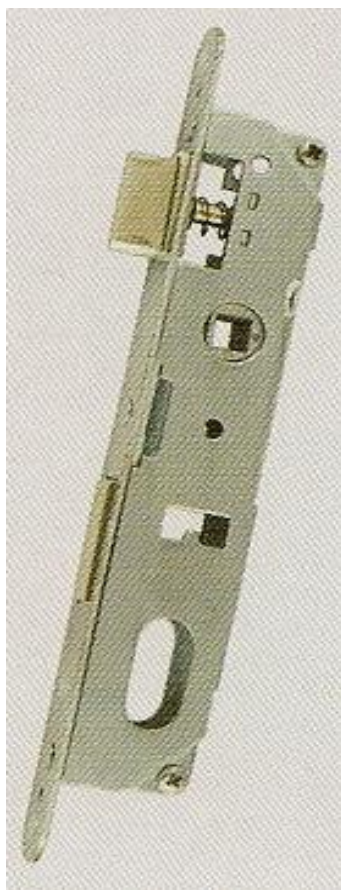

Code	Backset
ALDL0078516	16 mm
ALDL0078520	20 mm
ALDL0078525	25 mm
ALDL0078530	30 mm

Code	Backset
ALDL0088516	16 mm
ALDL0088520	20 mm
ALDL0088525	25 mm
ALDL0088530	30 mm

ALUMINUM DOOR LOCKS with CYLINDERS

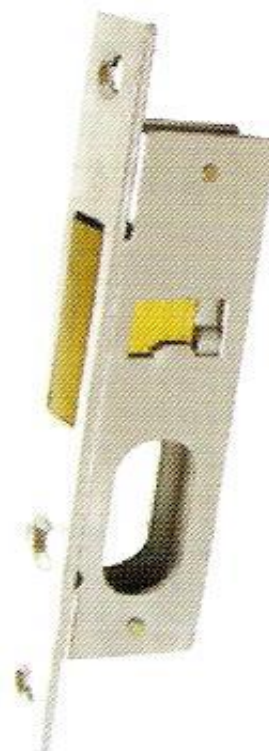
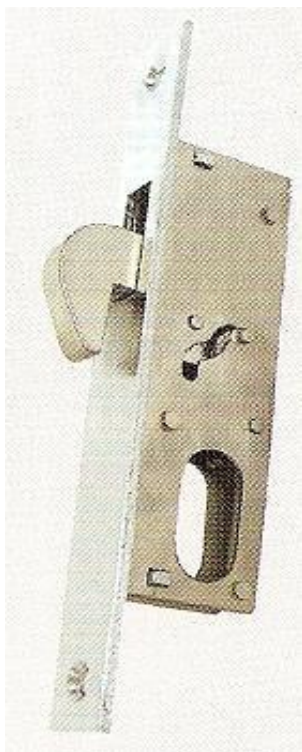

Code	Backset
ALDL00916	16 mm
ALDL00920	20 mm
ALDL00925	25 mm
ALDL00930	30 mm

Code	Backset
ALDL01016	16 mm
ALDL01020	20 mm
ALDL01025	25 mm
ALDL01030	30 mm



Trendy Hardware with Passion

**Range 5
Aluminum Door Closers**



www.domusitalya.com

info@domusitalya.com



ALUMINUM DOOR CLOSERS



Code	Power Size	Door Width	Door Weight
AHDCZC342	EN 2	850 mm	40 Kgs
AHDCZC343	EN 3	950 mm	60 Kgs
AHDCZC344	EN 4	1100 mm	80 Kgs
AHDCZC345	EN 5	1250 mm	100 Kgs



Code	Power Size	Door Width	Door Weight
AHDCZC622	EN 2	850 mm	40 Kgs
AHDCZC623	EN 3	950 mm	60 Kgs
AHDCZC624	EN 4	1100 mm	80 Kgs

ALUMINUM DOOR CLOSERS



Code	Power Size	Door Width	Door Weight
AHDCZC682	EN 2	850 mm	40 Kgs
AHDCZC683	EN 3	950 mm	60 Kgs
AHDCZC684	EN 4	1100 mm	80 Kgs



Code	Power Size	Door Width	Door Weight
AHDCZC102	EN 2	850 mm	40 Kgs

ALUMINUM DOOR CLOSERS



Code	Power Size	Door Width	Door Weight
AHDCZCG202	EN 2	850 mm	40 Kgs
AHDCZCG203	EN 3	950 mm	60 Kgs



Code	Power Size	Door Width	Door Weight
AHDCZC303	EN 3	950 mm	60 Kgs

ALUMINUM DOOR CLOSERS



Code	Power Size	Door Width	Door Weight
AHDCZC81A2	EN 2	850 mm	40 Kgs



Code	Power Size	Door Width	Door Weight
AHDCZC82A2	EN 2	850 mm	40 Kgs

Range 6
Insect Mesh Screens



ALUMINUM INSECT SCREEN WIRE MESH

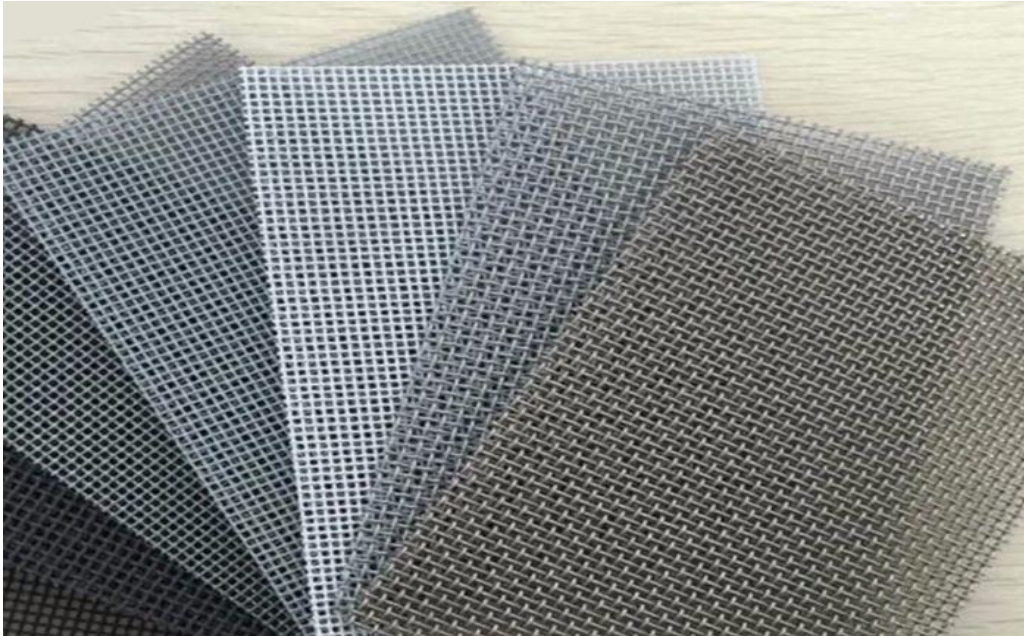

Code	Gauge
AGAISM1414	14 x 14
AGAISM1415	14 x 15
AGAISM1516	15 x 16
AGAISM1616	16 x 16
AGAISM1618	16 x 18
AGAISM1818	18 x 18

Wire Thicknesses : 0.20mm - 0.22mm - 0.23mm - 0.25mm

Available Colors : BLACK - SILVER - WHITE - GREEN

Roll Width from 30 cm till 200 cm

Roll Length / on request

FIBERGLASS INSECT SCREEN MESH

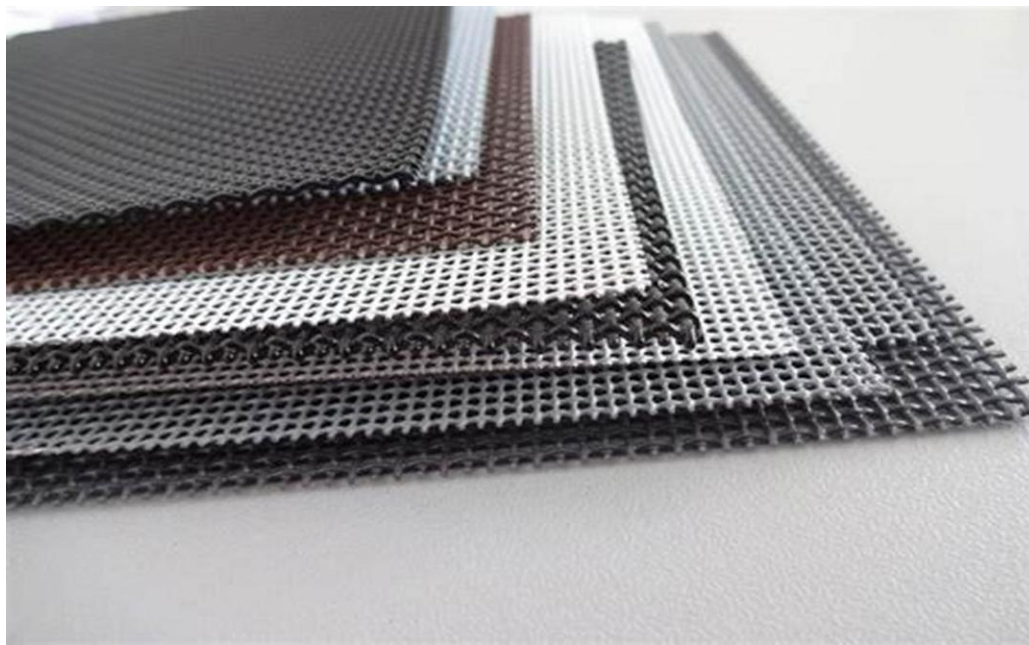

Code	Gauge
AGFISM1414	14 x 14
AGFISM1415	14 x 15
AGFISM1516	15 x 16
AGFISM1616	16 x 16
AGFISM1618	16 x 18
AGFISM1818	18 x 18

Mesh Weight : 90 gms - 100 gms - 105 gms - 110 gms - 120 gms

Available Colors : BLACK - GREY - WHITE - GREEN

Roll Width from 30 cm till 200 cm

Roll Length / on request



Trendy Hardware with Passion

Range 7
Window Roller Shutters



www.domusitalya.com

info@domusitalya.com



WINDOW ROLLER SHUTTERS



Code	Function	Height
AHWRSM090	Manual	90 cm
AHWRSM100		100 cm
AHWRSM110		110 cm
AHWRSM120		120 cm
AHWRSM150		150 cm
AHWRSW090	Motorized - Wall Switch	90 cm
AHWRSW100		100 cm
AHWRSW110		110 cm
AHWRSW120		120 cm
AHWRSW150		150 cm
AHWRSR090	Motorized - Remote Control	90 cm
AHWRSR100		100 cm
AHWRSR110		110 cm
AHWRSR120		120 cm
AHWRSR150		150 cm

Width - Customized on Request

Finishes : SILVER - BROWN ANODIZED - RAL COLORS



Trendy Hardware with Passion

**Range 8
Roller Blind Screens**



www.domusitalya.com

info@domusitalya.com



ROLLER BLIND SCREENS



Code	Function
AHRBSMxxx	Manual
AHRBSWxxx	Wall Switch
AHRBSRxxx	Remote Control

ROLLER BLIND SCREENS

