

**Part 3**  
**Public Areas Bathroom Accessories**



Hand Dryer



**BRAFAAT801**

Stainless Steel Push Button Hand Dryer  
W240 x H216 x D165 mm



**BRAFAAT802**

Push Button Hand Dryer  
W248 x H220 x D170 mm



**BRAFAAT803**

Stainless Steel Sensor Hand Dryer  
W240 x H216 x D165 mm



**BRAFAAT804**

Sensor Hand Dryer  
W310 x H212 x D177 mm



**BRAFAAT805**

Push Button Hand Dryer  
W248 x H220 x D170 mm



**BRAFAAT806**

Sensor Hand Dryer  
W248 x H220 x D170 mm

Stainless Steel Mirrors



**BRAPACAT501**

Frame Mirror with Shelf  
W450 x H750 mm



**BRAPACAT502**

Adjustble Tilt Mirror  
W500 x H700 mm



**BRAPACAT503**

Vandal Proof Security Mirror  
W305 x H406 mm



**BRAPACAT504**

Frame Mirror  
W450 x H600 mm

Fabricated of type 304 stainless steel with a #4 satin finish, 0.9mm for frame and 1.2mm for shelf. All shelf edges returned and hemmed for safety, shelf welded to face frame with 127mm (5") projection from mirror. Back plate and wall brackets fabricated of 1.0mm galvanized steel. Mirror is a 5mm or 6mm thick plate glass. Unit secured with wall brackets by theft-resistant screws.

### Mops - Brooms - Rags Holders



**BRAPACAT503**

Utility Hook Strip

3 hooks (660mm) - 4 hooks (915mm)



**BRAPACAT504**

Mop Holder & Rag Hooks

(3 mops & 2 rags) - (4 mops & 3 rags)



**BRAPACAT505**

Mop & Broom Holder

3 holders (660mm) - 4 holders (915mm)



**BRAPACAT507**

Utility Shelf with Mop Holders & Rags

3 hooks (660mm) - 4 hooks (915mm)



**BRAPACAT506**

Utility Hook Strip

3 holders (660mm) - 4 holders (915mm)

## Hooks



**BRAPACAT508**

Heavy Duty Robe Hook



**BRAPACAT509**

Heavy Duty Robe Hook



**BRAPACAT510**

Square Cloths Hook

W108 x H108 x D59 mm



**BRAPACAT511**

Square Cloths Hook

W108 x H108 x D59 mm



**BRAPACAT512**

Collapsible Hook



**BRAPACAT513**

Cloths Hook

### Bins



**BRAPACAT514**

Napkins Disposal with Lid  
W279 x H318 x D131 mm



**BRAPACAT515**

Wall Mounted Napkins Disposal  
W235 x H285 x D108 mm



**BRAPACAT516**

Disposal Bag Dispenser  
W90 x H135 x D27 mm



**BRAPACAT517**

Hygiene Paper Bags Dispenser  
W124 x H272 x D32 mm



**BRAPACAT518**

Wall Mounted Waste Receptacle  
W356 x H432 x D152 mm



**BRAPACAT519**

Surface Mounted Napkin Disposal  
W370 x H265 x D105 mm

### Bins



**BRAPACAT520**

Wall Mounted Corner Waste Receptacle

W264 x H410 x D257 mm



**BRAPACAT521**

Recessed Waste Receptacle

W438 x H775 x D210 mm



**BRAPACAT522**

Waste Receptacle with Handle

W300 x H400 x D130 mm



**BRAPACAT523**

Waste Receptacle - Push Lid

W438 x H775 x D210 mm

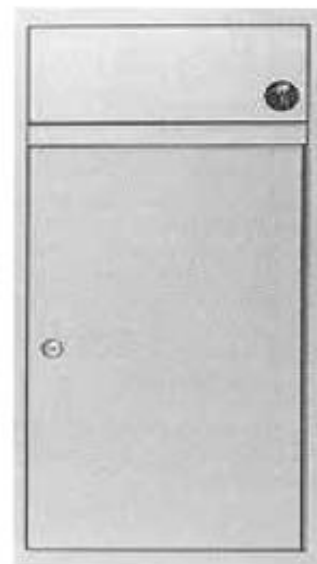

**BRAPACAT524**

Recessed Waste Receptacle

W330 x H810 x D108 mm

### Bins



**BRAPACAT525**

Round Ash-n-trash Receptacle

D250 x H600 mm



**BRAPACAT526**

Waste Receptacle with Swing Cover

D310 x H750 mm



**BRAPACAT527**

Waste Receptacle with Swing Cover

W380 x H680 x D350 mm



**BRAPACAT528**

Ash-n-trash Receptacle with Swing Cover

W300 x H610 x D250 mm



**BRAPACAT529**

Step In Waste Receptacle

W400 x H680 x D320 mm



**BRAPACAT530**

Ash-n-trash Receptacle

W250 x H610 x D250 mm



### Bins



**BRAPACAT531**

Pedal Step-on Bin & Carry Handle

3L - 5L - 12L - 20L



**BRAPACAT532**

Pedal Step-on Bin

3L - 5L - 12L - 20L



**BRAPACAT533**

Pedal Step-on Bin

6L - 12L - 20L - 30L



**BRAPACAT534**

Pedal Step-on Bin & Carry Handle

6L - 12L - 20L - 30L



**BRAPACAT535**

Trash Bin

6L - 12L - 20L - 30L



**BRAPACAT536**

Waste Receptacle

9 Liters

## Toilet Brush Holder



**BRAPACAT537**

Flip-top Ashtray  
W114 x H41 x D98 mm



**BRAPACAT538**

Counter Top Waste Chute  
Diam 170 x H120 mm



Black plastic holder inner bin

**BRAPACAT539**

Toilet Brush Holder



**BRAPACAT540**

Toilet Brush Holder



**BRAPACAT541**

Toilet Brush Holder



**BRAPACAT542**

Toilet Brush Holder

## Baby Changing Station



### **BRAFAAT851**

Baby Changing Station  
W570 x H920 x D100 mm



### **BRAFAAT852**

Baby Changing Station  
W889 x H508 x D102 mm



### **BRAFAAT853**

Child Protection Seat



### **BRAFAAT854**

Baby Changing Station  
W616 x H893 x D98 mm

Shower Curtain Rods



**BRASCAT951**

SS Shower Curtains Rod & Flanges  
25mm dia. - lengths up to 1.85 cm



**BRASCAT952**

SS L Shape Shower Curtains Rod & Flanges  
25mm dia. - lengths up to 1.85 cm



**BRASCAT953**

Curved Shape Shower Curtain Rod  
25mm dia. - lengths up to 1.85 cm

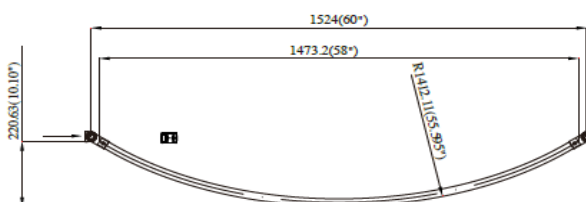

Shower Curtain Rods



**BRASCAT954**

Stainless Steel Shower Curtain Flange



**BRASCAT955**

Stainless Steel Shower Curtain Flange



**BRASCAT956**

Stainless Steel Shower Curtain Flange



**BRASCAT957**

Stainless Steel Shower Curtain Flange

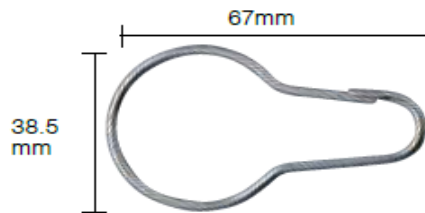

**BRASCAT958**

Stainless Steel Shower Curtain Hook



**BRASCAT959**

Stainless Steel Shower Curtain Hook



**BRASCAT960**

Stainless Steel Shower Curtain Hook

Recessed Paper Towel Dispenser & Waste Receptacle

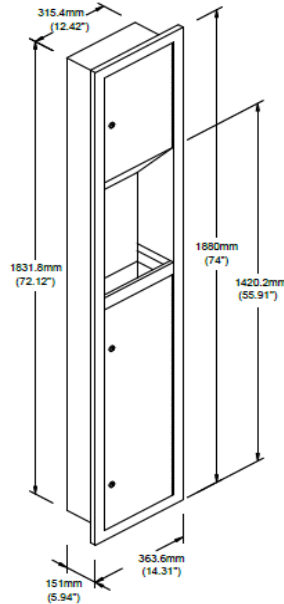

Dispenses 600 C-fold, 800 Multi-fold Paper Towels

Removable 10.5 gal. (39.7L)

Wall Opening W324 x H1842 x D159 mm

**SPECIFICATIONS**

Cabinet fabricate by 0.8mm thickness and Door shall be double pan construction fabricated by 1.2mm thickness type 304 stainless steel with a 1/4"(6mm) thick "NO-Flex" structural fiberboard core. Mount doors to cabinet body by a heavy-duty 3/16"(5mm) diameter stainless steel piano hinge. Recessed cabinet shall be fabricated of 20 gauge(0.8mm) stainless steel with face trim of one piece construction with no miltres or welding and returning 1/4"(6mm) to wall. All doors shall be provided with a tumbler lock keyed alike. Internal waste containers are made of 0.5mm stainless steel.

**BRAPAC101**

SSS Recessed Paper Towel Dispenser & Disposal

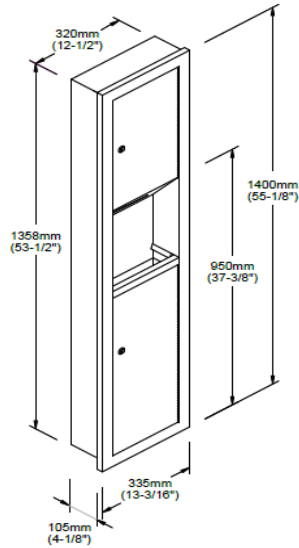

Dispenses 600 C-fold, 800 Multi-fold Paper Towels

Removable 4.5 gal. (17L)

Overall Size W335 x H1400 x D105 mm

**SPECIFICATIONS**

Cabinet fabricate by 0.8mm thickness and Door shall be double pan construction fabricated by 1.2mm thickness type 304 stainless steel with a 1/4"(6mm) thick "NO-Flex" structural fiberboard core. Mount doors to cabinet body by a heavy-duty 3/16"(5mm) diameter stainless steel piano hinge. Recessed cabinet shall be fabricated of 20 gauge(0.8mm) stainless steel with face trim of one piece construction with no miltres or welding and returning 1/4"(6mm) to wall. All doors shall be provided with a tumbler lock keyed alike. Internal waste containers are made of 0.5mm stainless steel.

BRAPAC102

SSS Recessed Paper Towel Dispenser & Waste Receptacle



Dispenses 600 C-fold, 800 Multi-fold Paper Towels

Removable 11 gal. (45L)

Overall Size W400 x H1390 x D110 mm

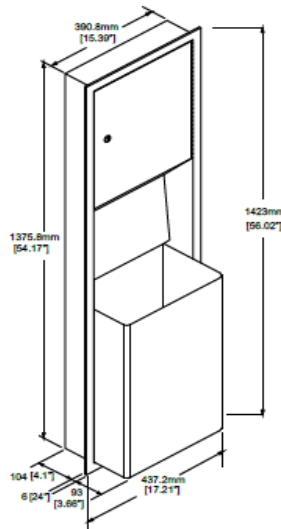

BRAPAC103

BRAPAC104

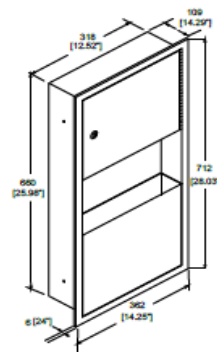

Dispenses 350 C-fold, 475 Multi-fold Paper Towels

Removable 2 gal. (7.6L)

Overall Size W362 x H711 x D109 mm





SSS Recessed Paper Towel Dispenser & Disposal



Dispenses 600 C-fold, 800 Multi-fold Paper Towels

Removable 5 gal. (19L)

Overall Size W300 x H1397 x D115 mm

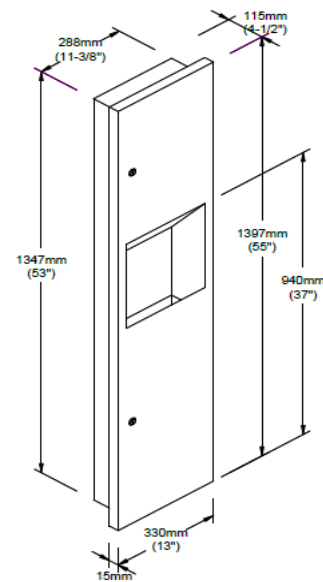

**SPECIFICATIONS**

Cabinet fabricate by 0.8mm thickness and Door shall be double pan construction fabricated by 1.2mm thickness type 304 stainless steel with a 1/4"(6mm) thick "NO-Flex" structural fiberboard core. Mount doors to cabinet body by a heavy-duty 3/16"(5mm) diameter stainless steel piano hinge. Recessed cabinet shall be fabricated of 20 gauge(0.8mm) stainless steel with face trim of one piece construction with no miltres or welding and returning 1/4"(6mm) to wall. All doors shall be provided with a tumbler lock keyed alike. Internal waste containers are made of 0.5mm stainless steel.

BRAPAC105

SSS Recessed Paper Towel Dispenser



Dispenses 600 C-fold, 800 Multi-fold Paper Towels

Wall Opening W305 x H673 x D108 mm

Overall Size W330 x H711 x D115 mm

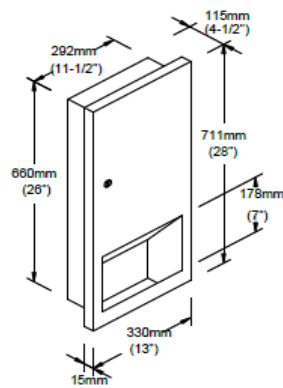

BRAPAC106



Dispenses 350 C-fold, 475 Multi-fold Paper Towels

Wall Opening W300 x H400 x D108 mm

Overall Size W324 x H438 x D115 mm

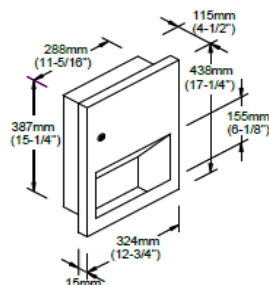

BRAPAC107

### Surface Hanging Paper Towel Dispensers



0.7mm - SS304 Stainless Steel

400 C-fold or 525 Multi-fold Paper Towels

W280 x H369 x D102 mm

BRAPAC108



0.7mm - SS304 Stainless Steel

400 C-fold or 525 Multi-fold Paper Towels

W280 x H369 x D128 mm

BRAPAC109

## Paper Towel Dispenser



**Auto Cut Dispenser**

**White ABS**

**W296 x H395 x D238 mm**

**BRAPAC110**



**Roll Paper Towel Dispenser**

**Rolls of 205 or 230 mm**

**W308 x H375 x D235**

**BRAPAC111**



**Paper Towel Dispenser**

**350 C-fold Paper Towels**

**W275 x H375 x D105**

**BRAPAC112**

### Paper Towel Dispenser



**Paper Towel Dispenser**

**250 C-fold Paper Towels**

**W257 x H256 x D125 mm**

**BRAPAC113**



**Paper Towel Dispenser**

**300 C-fold Paper Towels**

**W275 x H375 x D105 mm**

**BRAPAC114**



**Paper Towel Dispenser**

**300 C-fold Paper Towels**

**W272 x H385 x D131 mm**

**BRAPAC115**

## Paper Roll Dispenser



**Toilet Roll Dispenser**

**2 rolls x 1800 sheets**

**W152 x H305 x D173 mm**

**BRAPAC114**



**Recessed Roll Dispenser**

**2 rolls x 1800 sheets**

**W200 x H356 x D173 mm**

**BRAPAC115**



**Recessed Roll Dispenser**

**4 rolls x 1800 sheets**

**W356 x H349 x D311 mm**

**BRAPAC116**

## Paper Roll Dispenser



**Recessed Roll Dispenser**

**with Napkin Disposal**

**W438 x H546 x D165 mm**

**BRAPAC117**



**Recessed Toilet Seat Cover**

**Tissue Paper Dispenser**

**Sanitary Napkin Disposal**

**2 gallons receptacle**

**W405 x H745 x D110 mm**

**BRAPAC118**



**Recessed Roll Dispenser**

**0.6 Gallons (2.8L)**

**W435 x H325 x D107 mm**

**BRAPAC119**

## Paper Roll Dispenser



**Toilet Roll Dispenser**

**2 rolls x 1800 sheets**

**W114 x H295 x D125 mm**

**BRAPAC120**



**Toilet Roll Dispenser**

**3 rolls x 1800 sheets**

**W114 x H418 x D125 mm**

**BRAPAC121**



**Interfold Tissue Dispenser**

**350 tissues**

**W145 x H235 x D110 mm**

**BRAPAC122**



## Paper Roll Holder



**Paper Roll Holder**

**1 roll x 1800 sheets**

**W140 x H60 x D109 mm**

**BRAPAC123**



**Toilet Roll Dispenser**

**2 rolls x 1800 sheets**

**W265 x H60 x D109 mm**

**BRAPAC124**



**Recessed Roll Dispenser**

**1 roll x 1800 sheets**

**Diam 185 x D115 mm**

**BRAPAC125**

### Toilet Paper Holder



**Tissue Paper Dispenser**

**3600 sheets**

**W130 x H140 x D120 mm**

**BRAPAC126**



**Twin Pack Interfold Dispenser**

**900 interfold sheets**

**W145 x H297 x D130 mm**

**BRAPAC127**



**Jumbo Roll TTP Dispenser**

**250 mtrs long 2-ply tissue**

**Diam 273 x D120 mm**

**BRAPAC128**

## Toilet Paper Holder



**Jumbo Roll TTP Dispenser**

**250 mtrs long 2-ply tissue**

**Diam 273 x D120 mm**

**BRAPAC129**



**4 Rolls TTP Dispenser**

**4 standard rolls tissue paper**

**Diam 320 x D122 mm**

**BRAPAC130**

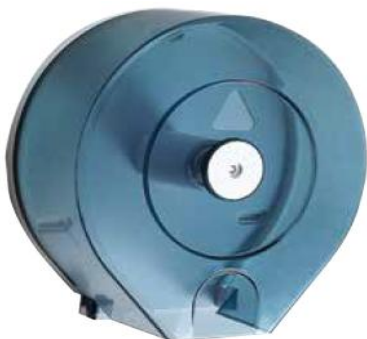

**PVC Jumbo Roll TTP Dispenser**

**250 mtrs long 2-ply tissue**

**W270 x H270 x D126 mm**

**BRAPAC131**

### Toilet Seat Cover Dispenser



**Recessed Cover Dispenser**

**500 single toilet seat covers**

**W438 x H324 x D67 mm**

**BRAPAC132**



**Toilet Seat Cover Dispenser**

**250 single toilet seat covers**

**W400 x H280 x D50 mm**

**BRAPAC133**



**PVC Seat Cover Dispenser**

**200 single toilet seat covers**

**W400 x H280 x D50 mm**

**BRAPAC134**

## Liquid Soap Dispenser



**Push Up Soap Dispenser**

**Plastic inner tank 1000 ml**

**W100 x H245 x D121 mm**

**BRAPAC235**



**Soap Dispenser - ABS Valve**

**1.2 ltrs liquid tank capacity**

**W206 x H121 x D72 mm**



**BRAPAC236**



**Soap Dispenser - SS Valve**

**1.2 ltrs liquid tank capacity**

**W206 x H121 x D72 mm**



**BRAPAC237**

## Liquid Soap Dispenser



Soap Dispenser - SS Valve

1.2 ltrs liquid tank capacity

W121 x H206 x D72 mm

BRAPAC238



Soap Dispenser - ABS Valve

1.2 ltrs liquid tank capacity

W121 x H206 x D72 mm

BRAPAC239



Soap Dispenser - Brass Valve

1.2 ltrs liquid tank capacity

W177 x H156 x D72 mm

BRAPAC240

## Liquid Soap Dispenser



**Recessed Soap Dispenser**

**1.2 ltrs SS liquid tank**

**W260 x H150 x D109 mm**

**BRAPAC238**



**Recessed Soap Dispenser**

**1.2 ltrs SS liquid tank**

**W150 x H260 x D109 mm**

**BRAPAC239**



**Surface Soap Dispenser**

**1.2 ltrs liquid tank capacity**

**W80 x H168 x D156 mm**

**BRAPAC240**

## Liquid Soap Dispenser



**Wall mounted Soap Dispenser**

**1.2 ltrs ABS liquid tank**

**W105 x H260 x D109 mm**

**BRAPAC241**



**Push Type Soap Dispenser**

**1.0 ltrs ABS liquid tank**

**W101 x H269 x D112 mm**

**BRAPAC242**



**Foam Soap Dispenser**

**1.0 ltrs ABS liquid tank**

**W117 x H269 x D113 mm**

**BRAPAC243**



## Liquid Soap Dispenser



**Push-Up Liquid Soap Dispenser**

**0.7 ltrs PE liquid tank**

**W102 x H194 x D108 mm**

**BRAPAC244**



**Liquid Soap Dispenser**

**0.5 ltrs ABS liquid tank**

**PE Body**

**BRAPAC245**



**ABS Foam Soap Dispenser**

**1.0 ltrs ABS liquid tank**

**W102 x H269 x D113 mm**

**BRAPAC246**

### Liquid Soap Dispenser



**Liquid Soap Dispenser**

**0.8 ltrs PE liquid tank**

**W102 x H194 x D108 mm**

**BRAPAC247**



**Liquid Soap Dispenser**

**0.4 ltrs ABS liquid tank**

**W102 x H194 x D93 mm**

**BRAPAC248**



**2 tanks Soap Dispenser**

**0.4 ltrs x 2 liquid tank**

**W156 x H269 x D96 mm**

**BRAPAC249**

## Liquid Soap Dispenser



**Liquid Soap Dispenser**

**0.2 ltrs PE liquid tank**

**W93 x H194 x D108 mm**

**BRAPAC250**



**2 tanks Soap Dispenser**

**0.2 ltrs x 2 PE liquid tank**

**W122 x H194 x D93 mm**

**BRAPAC251**



**3 tanks Soap Dispenser**

**0.2 ltrs x 3 PE liquid tank**

**W172 x H194 x D93 mm**

**BRAPAC252**

## Liquid Soap Dispenser



**Liquid Soap Dispenser**

**0.7 ltrs PE liquid tank**

**W110 x H106 x D165 mm**

**BRAPAC250**



**Liquid Soap Dispenser**

**0.75 ltrs PE liquid tank**

**W110 x H106 x D185 mm**

**BRAPAC251**



**Sensor Soap Dispenser**

**1.4 ltrs PE liquid tank**

**W145 x H239 x D145 mm**

**BRAPAC252**

Stainless Steel Accessories - Serie LUNA



**BRAPACAT331**

Single Robe Hook



**BRAPACAT332**

Towel Ring



**BRAPACAT333**

Toilet Paper Holder



**BRAPACAT334**

Towel Bar 24"



**BRAPACAT335**

Soap Holder



**BRAPACAT336**

Glass Shelf



**BRAPACAT337**

Robe Hook Strip Bar



**BRAPACAT338**

Toilet Brush Holder

Stainless Steel Accessories - Serie COMO



**BRAPACIT355**

Coat Hook



**BRAPACIT356**

Soap Holder



**BRAPACIT357**

Soap Basket



**BRAPACIT358**

Tumbler Holder



**BRAPACIT359**

Towel Ring



**BRAPACIT360**

Toilet Paper Holder



**BRAPACIT361**

Towel Bar



**BRAPACIT362**

Double Tower Bar



**BRAPACIT363**

Towel Shelf



**BRAPACIT364**

Glass Shelf

## Stainless Steel Accessories - Serie VERO



**BRAPACIT365**

Coat Hook



**BRAPACIT366**

Soap Holder



**BRAPACIT367**

Soap Basket



**BRAPACIT368**

Tumbler Holder



**BRAPACIT369**

Towel Ring



**BRAPACIT370**

Toilet Paper Holder



**BRAPACIT371**

Towel Bar



**BRAPACIT372**

Double Tower Bar



**BRAPACIT373**

Towel Shelf

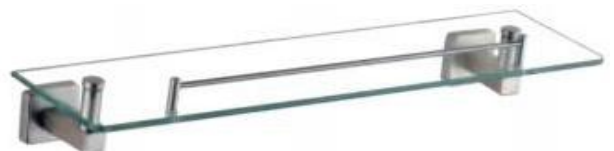

**BRAPACIT374**

Glass Shelf

## Stainless Steel Accessories - Serie ROMA



**BRAPACIT375**

Coat Hook



**BRAPACIT376**

Soap Holder



**BRAPACIT377**

Soap Basket



**BRAPACIT378**

Tumbler Holder



**BRAPACIT379**

Towel Ring



**BRAPACIT380**

Toilet Paper Holder



**BRAPACIT381**

Towel Bar



**BRAPACIT382**

Double Tower Bar



**BRAPACIT383**

Liquid Soap Dispenser



**BRAPACIT384**

Glass Shelf



## Stainless Steel Accessories



**BRAPACAT301**

Single Robe Hook



**BRAPACAT302**

Double Robe Hook



**BRAPACAT303**

Double Robe Hook



**BRAPACAT304**

Towel Hook



**BRAPACAT305**

Hat & Coat Hook



**BRAPACAT306**

Soap Dish

### Stainless Steel Accessories



**BRAPACAT307**

Toothbrush & Tumbler Holder



**BRAPACAT308**

Toilet Paper Dispenser



**BRAPACAT309**

Towel Shelf with Drying Rod

L/mm : 457 - 508 - 610 - 762



**BRAPACAT310**

Shower Grab Bar

L/mm : 457 - 508 - 610 - 762



**BRAPACAT311**

Shelf L508mm



**BRAPACAT312**

Angle Bar with Soap Dish

### Stainless Steel Accessories



**BRAPACAT313**

Surface Mounted Roll Tissue Holder  
W140 x H140 x D51 mm



**BRAPACAT314**

Semi-Recessed Double Roll Tissue Holder  
W314 x H165 x D46 mm



**BRAPACAT315**

Surface Mounted Double Roll Tissue Holder  
W290 x H141 x D79 mm



**BRAPACAT316**

Recessed Roll Toilet Tissue Holder  
W140 x H140 x D51 mm



**BRAPACAT317**

Semi-Recessed Double Roll Tissue Holder  
W141 x H290 x D51 mm



**BRAPACAT318**

Recessed Double Roll Toilet Tissue Holder  
W290 x H141 x D79 mm

### Stainless Steel Accessories



**BRAPACAT319**

Toilet Paper Holder with Cover

W132 x H72 mm



**BRAPACAT320**

Double Toilet Paper Holder with Cover

W264 x H72 mm



**BRAPACAT321**

Facial Tissue Paper Dispenser

W250 x H130 x D72 mm



**BRAPACAT322**

Recessed Facial Tissue Paper Dispenser

W250 x H130 x D72 mm



**BRAPACAT323**

Recessed Soap Dish

W159 x H159 x D45 mm



**BRAPACAT324**

Recessed Soap Dish with Bar

W159 x H159 x D45 mm

Stainless Steel Accessories



**BRAPACAT325**

Towel Shelf



**BRAPACAT326**

Towel Shelf



**BRAPACAT327**

Towel Bar



**BRAPACAT328**

Double Towel Shelf



**BRAPACAT329**

Towel Shelf



**BRAPACAT330**

Corner Utility Basket

## Zinc Alloy Accessories - Serie VENIZIA



**BRAPACAT339**

Tropezoid Towel Ring



**BRAPACAT340**

Soap Dish Holder



**BRAPACAT341**

Round Towel Ring



**BRAPACAT342**

Towel Bar 24"



**BRAPACAT343**

Coat Hook & Bumper



**BRAPACAT344**

Toilet Paper Holder



**BRAPACAT345**

Double Robe Hook



**BRAPACAT346**

Toilet Paper Holder

Zinc Alloy Accessories - Serie LECCO



**BRAPACAT347**

Double Robe Hook



**BRAPACAT348**

Soap Dish Holder



**BRAPACAT349**

Tumbler Holder with Glass cup



**BRAPACAT350**

Toilet Paper Holder



**BRAPACAT351**

Towel Ring



**BRAPACAT352**

Towel Bar 24"



**BRAPACAT353**

Glass Shelf 24"



**BRAPACAT354**

Double Towel Bar 24"

Zinc Alloy Accessories - Serie MILANO



**BRAPACAT355**

Double Robe Hook



**BRAPACAT356**

Single Robe Hook



**BRAPACAT357**

Tumbler Holder with Glass cup



**BRAPACAT358**

Soap Dish Holder



**BRAPACAT359**

Towel Ring



**BRAPACAT360**

Toilet Paper Holder



**BRAPACAT353**

Glass Shelf 24"



**BRAPACAT354**

Towel Bar 24"



## Stainless Steel Grap Bars



**BRAPACAT601**

Grap Bars - 30mm diam - 40mm diam  
length from 300mm till 1200mm



**BRAPACAT602**



**BRAPACAT603**



**BRAPACAT604**



**BRAPACAT605**

Stainless Steel Grap Bars



**BRAPACAT605**

Grab Bar with Extra Support - 1200mm

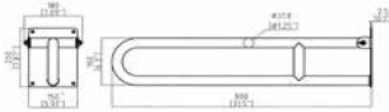

**BRAPACAT606**

Swing Up Grab Bar

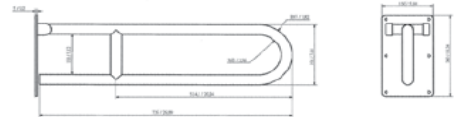

**BRAPACAT607**

Heavy Duty Back Plate Swing Up Grab Bar

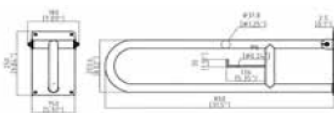

**BRAPACAT608**

Swing Up Grab Bar with Toilet Paper Holder

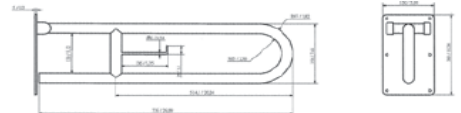

**BRAPACAT609**

Heavy Duty Back Plate Swing Up Grab Bar

Folding Shower Seat



**BRAPACAT672**

W457 x D408 mm



**BRAPACAT673**

W457 x D394 mm



**BRAPACAT674**

W600 x D450 mm



**BRAPACAT675**

W600 x D450 mm



**BRAPACAT676**

W531 x D253 mm



**BRAPACAT677**

W313 x L498 x D169 mm